



HP Z220 SFF, Z220 CMT, Z420, Z620, and Z820 Workstation Series

User Guide



View our **Z620**
inventory here

Copyright Information

© Copyright 2014 Hewlett-Packard Development Company, L.P.

Fourth Edition: June 2014

First Edition: March 2012

Part number: 669529-004

Warranty

Hewlett-Packard Company shall not be liable for technical or editorial errors or omissions contained herein or for incidental or consequential damages in connection with the furnishing, performance, or use of this material. The information in this document is provided "as is" without warranty of any kind, including, but not limited to, the implied warranties of merchantability and fitness for a particular purpose, and is subject to change without notice. The warranties for HP products are set forth in the express limited warranty statements accompanying such products.

Nothing herein should be construed as constituting an additional warranty.

The information contained herein is subject to change without notice. The only warranties for HP products and services are set forth in the express warranty statements accompanying such products and services. Nothing herein should be construed as constituting an additional warranty. HP shall not be liable for technical or editorial errors or omissions contained herein.

Trademark Credits

Microsoft and Windows are U.S. registered trademarks of Microsoft Corporation.

Intel is a trademark of Intel Corporation in the U.S. and other countries.

FireWire is a trademark of Apple Computer, Inc., registered in the U.S. and other countries.

About this guide

This guide provides setup and troubleshooting information for the HP Z Workstation series. It includes these topics:

Guide topics
Locating HP resources on page 1
Workstation features on page 7
Setting up the workstation on page 20
Setting up, backing up, restoring, and recovering Windows 7 on page 32
Setting up and restoring Windows 8 on page 37
Setting up and restoring Linux on page 42
Diagnostics and Minor Troubleshooting on page 49
Routine Care on page 55

 **TIP:** If you do not find what you are looking for in this guide:

- Find technical details in the *Maintenance and Service Guide* for your workstation at http://www.hp.com/support/workstation_manuals.
 - View component installation videos at <http://www.hp.com/go/sml>.
 - See additional information on your workstation at <http://www.hp.com/go/workstations>.
-

Table of contents

1 Locating HP resources	1
Product information	1
Support	3
Product documentation	4
Product diagnostics	5
Product updates	6
2 Workstation features	7
HP Z220 SFF Workstation components	8
Z220 SFF Workstation front panel	8
Z220 SFF Workstation rear panel	9
HP Z220 CMT Workstation components	10
HP Z220 CMT Workstation front panel	10
HP Z220 CMT Workstation rear panel	11
HP Z420 Workstation components	12
HP Z420 Workstation front panel	12
HP Z420 Workstation rear panel	13
HP Z620 Workstation components	14
HP Z620 Workstation front panel	14
HP Z620 Workstation rear panel	15
HP Z820 Workstation components	16
HP Z820 Workstation front panel	16
HP Z820 Workstation rear panel	17
Product specifications	18
Workstation weights and dimensions	18
Environmental specifications	19
3 Setting up the workstation	20
Ensuring proper ventilation	20
Setup procedures	22
Adding monitors	23
Planning for additional monitors	23
Finding supported graphics cards	25
Matching graphics cards to monitor connectors	25
Identifying monitor connection requirements	25
Connecting and configuring monitors	26

Using a third-party graphics configuration utility	28
Customizing the monitor display (Windows)	28
Converting to desktop configuration (Z220 CMT and Z420)	29
Installing optional components	31
Security	31
Product recycling	31
4 Setting up, backing up, restoring, and recovering Windows 7	32
Setting up the Windows 7 operating system	32
Installing or upgrading device drivers	32
Transferring files and settings	33
Backing up, restoring, and recovering Windows 7	33
Backing up your information	33
System Restore	34
System Recovery	35
System Recovery from a recovery partition image	35
Using HP Recovery Disc operating system discs	36
5 Setting up and restoring Windows 8	37
Additional information	37
Setting up the Windows 8 operating system	37
Downloading Windows 8 updates	38
Backup and recovery in Windows 8	38
Backing up your information	38
Performing a system recovery	39
Using the Windows recovery tools	39
Using F11 recovery tools	40
Using HP Windows 8 restore media (purchased separately)	41
6 Setting up and restoring Linux	42
HP Linux Support Matrix	42
HP Installer Kit for Linux (HPIKL)	43
Setting up Red Hat Enterprise Linux	43
HPIKL driver disc	44
Installing with the HP Red Hat Linux driver disc	44
Warranty	44
Setting up SUSE Linux Enterprise Desktop (SLED)	45
Setting up preloaded SLED	45
Installing SLED with the DVD Installer Kit	45
Warranty	45

Restoring SLED (preloaded systems only)	46
Proprietary graphics drivers	46
7 Updating the workstation	47
Updating the workstation after first boot	47
Upgrading the BIOS	47
Determining the current BIOS version	47
Upgrading BIOS	48
Upgrading device drivers	48
8 Diagnostics and Minor Troubleshooting	49
Calling support	49
Locating ID labels	50
Locating warranty information	50
HP troubleshooting resources and tools	50
HP Support Assistant (HPSA)	50
Online support	51
Troubleshooting a problem	52
Instant Support and Active Chat	52
Customer Advisories, Customer and Security Bulletins, and Customer Notices	52
Product Change Notifications	52
Helpful hints	53
At startup	53
During operation	53
Customer self repair	54
Other troubleshooting options	54
9 Routine Care	55
General cleaning safety precautions	55
Cleaning the chassis	55
Cleaning the keyboard	56
Cleaning the monitor	56
Cleaning the mouse	57

1 Locating HP resources

This section provides information on the following resources for your HP workstation:

Topics
Product information on page 1
<ul style="list-style-type: none">• Technical specifications• HP Cool Tools• Regulatory information• Accessories• System board• Serial number, Certificate of Authenticity, and Genuine Microsoft Label
Support on page 3
<ul style="list-style-type: none">• Product support• HP Support Assistant• Warranty information
Product documentation on page 4
<ul style="list-style-type: none">• HP and third-party documentation, white papers• Product notifications• Technical specifications (QuickSpecs)• Customer Advisories, Security Bulletins, Notices
Product diagnostics on page 5
<ul style="list-style-type: none">• HP Vision Diagnostics• HP PC Hardware Diagnostics• Audible beeps and LED code definitions• POST error codes
Product updates on page 6
<ul style="list-style-type: none">• Driver and BIOS updates• Operating systems

Product information

Table 1-1 Product information

Topic	Location
Technical specifications	Go to www.hp.com/go/quickspecs . In the left pane, select your region and then select Workstations .

Table 1-1 Product information (continued)

Topic	Location
HP Cool Tools (Windows® 7 only)	<p>Most HP workstations with the Windows 7 operating system are preloaded with tools that may enhance system performance and with additional software that is not automatically installed during first boot. To access these applications:</p> <ul style="list-style-type: none">• Click the HP Cool Tools icon on the desktop, or• Open the HP Cool Tools folder by selecting Start > All Programs > HP > HP Cool Tools. <p>To learn more about these applications, click HP Cool Tools—Learn More.</p> <p>To install or launch the applications, click the appropriate application icon.</p> <p>Additional information is located in the <i>Maintenance and Service Guide</i> for your workstation on the web at http://www.hp.com/support/workstation_manuals/.</p>
Regulatory information	Refer to the <i>Safety & Regulatory Information</i> guide for product regulatory information. You can also refer to the regulatory label on the workstation chassis.
Accessories	For complete and current information on supported accessories and components, see http://www.hp.com/go/workstations .
System board	A diagram of the system board is located on the inside of the side access panel (tower and desktop configurations) or on the inside of the chassis (all-in-one configurations). Additional information is located in the <i>Maintenance and Service Guide</i> for your workstation on the web at http://www.hp.com/support/workstation_manuals/ .
Serial number, Certificate of Authenticity (COA) labels, and Genuine Microsoft Label (GML) (if applicable)	Serial number labels are on the top or back panel (tower and desktop configurations). The COA (Windows 7) label and GML (Windows 8) are typically located near the serial number label. Some workstations have this label on the bottom panel.
Linux	For information on running Linux on HP workstations, go to http://www.hp.com/linux/ , then select Linux on Workstations from the list on the left.

Support

Table 1-2 Support

Topic	Location
Product support	<p>For U.S. support, go to http://www.hp.com/go/contactHP.</p> <p>For worldwide support, go to http://welcome.hp.com/country/us/en/wwcontact_us.html.</p> <p>Here you can:</p> <ul style="list-style-type: none">• Chat online with an HP technician• Obtain email support• Find support telephone numbers• Locate an HP service center
HP Support Assistant (Windows 7 only)	<p>HP Support Assistant is an HP application that helps you maintain the performance of your workstation and resolve problems through automated updates and tune-ups, built-in diagnostics, and guided assistance.</p> <p>To access HP Support Assistant, double-click the HP Support Assistant icon on your desktop.</p> <p>NOTE: HP Support Assistant is pre-installed on select HP workstations running Windows 7. HP Support Assistant is not available on workstations running Linux or Windows 8.</p>
Warranty information	<p>To locate base warranty information, see http://www.hp.com/support/warranty-lookuptool.</p> <p>To locate an existing Care Pack, see http://www.hp.com/go/lookuptool.</p> <p>To extend a standard product warranty, see http://h20219.www2.hp.com/services/us/en/warranty/carepack-overview.html. HP Care Pack Services offer upgraded service levels to extend and expand a standard product warranty.</p> <p>You can find the expressly provided HP Limited Warranty applicable to your product in the start menu on your PC and/or in the CD/DVD provided in the box. For some countries/regions, a printed HP Limited Warranty is provided in the box. In countries/regions where the warranty is not provided in printed format, you may request a printed copy from http://www.hp.com/go/orderdocuments or write to:</p> <ul style="list-style-type: none">• North America: Hewlett Packard, MS POD, 11311 Chinden Blvd, Boise, ID 83714, USA• Europe, Middle East, Africa: Hewlett-Packard, POD, Via G. Di Vittorio, 9, 20063, Cernusco/ Naviglio (MI), Italy• Asia Pacific: Hewlett-Packard, POD, P.O. Box 200, Alexandra Post Office, Singapore 911507 <p>Please include your product number, warranty period (found on your serial number label), name, and postal address.</p>

Product documentation

Table 1-3 Product documentation

Topic	Location
HP user documentation, white papers, and third-party documentation	For the latest online documentation, go to http://www.hp.com/support/workstation_manuals . These include this User Guide and the <i>Maintenance and Service Guide</i> .
Removal and replacement videos	To learn how to remove and replace workstation components, go to http://www.hp.com/go/sml .
Product notifications	Subscriber's Choice is an HP program that allows you to sign up to receive driver and software alerts, proactive change notifications (PCNs), the HP newsletter, customer advisories, and more. Sign up at www.hp.com/united-states/subscribe/gateway/?jumpid=go/subscribe-gate1 .
Technical specifications	The Product Bulletin contains QuickSpecs for HP Workstations. QuickSpecs include information about the operating system, power supply, memory, CPU, and many other system components. To access the QuickSpecs, see http://www.hp.com/go/quickspecs/ .
Customer Advisories, Security Bulletins, and Notices	To find advisories, bulletins, and notices: <ol style="list-style-type: none">1. See http://www.hp.com/go/workstationsupport.2. Select the desired product.3. From the Resources section, select See more...4. Use the scroll bar to select Customer Advisories, Customer Bulletins, or Customer Notices.

Product diagnostics

Table 1-4 Product diagnostics

Topic	Location
Windows 7 Diagnostics tools: <ul style="list-style-type: none">• HP Vision Diagnostics (Z420, Z620, Z820)• HP PC Hardware Diagnostics (Z220 SFF, Z220 CMT)	<p>The HP Vision Diagnostics utility is pre-installed on select Windows 7 workstations.</p> <p>The HP PC Hardware Diagnostics tool is pre-installed on Windows 7 workstations.</p> <p>Additional information is located in the <i>Maintenance and Service Guide</i> for your workstation on the web at http://www.hp.com/support/workstation_manuals/.</p>
Windows 8 Diagnostics tools: <ul style="list-style-type: none">• HP Vision Diagnostics (Z420, Z620, Z820)• HP PC Hardware Diagnostics (Z220 SFF, Z220 CMT)	<p>The HP Vision Diagnostics utility is pre-installed on select Windows 8 workstations.</p> <p>The HP PC Hardware Diagnostics tool is pre-installed on Windows 8 workstations.</p> <p>Additional information is located in the <i>Maintenance and Service Guide</i> for your workstation on the web at http://www.hp.com/support/workstation_manuals/.</p>
Audible beep and LED code definitions	Refer to the workstation <i>Maintenance and Service Guide</i> for your workstation at http://www.hp.com/support/workstation_manuals/ .
POST error codes	Refer to the workstation <i>Maintenance and Service Guide</i> for your workstation at http://www.hp.com/support/workstation_manuals/ .

Product updates

Table 1-5 Product updates

Topic	Location
Driver and BIOS updates	<p>See http://www.hp.com/go/workstationsupport to verify that you have the latest drivers for the workstation.</p> <p>To determine the current workstation BIOS on your workstation, follow these steps during system power up:</p> <ol style="list-style-type: none">1. Power on the workstation, and press Esc during boot up.2. Press F10 to enter the F10 Setup utility.3. Go to File > System Information. Note the BIOS version and date and compare it with the BIOS versions that appear on the HP website. <p>For Windows 7, you can also find the BIOS version number, as follows:</p> <ol style="list-style-type: none">1. Go to Start > All Programs > Accessories > System Tools > System Information.2. In the right pane, find the line with BIOS Version/Date.3. Note the BIOS version and date and compare it with the versions that appear on the HP website. <p>In Windows 8, you can also find the BIOS version number, as follows:</p> <ol style="list-style-type: none">1. Point to the upper-right or lower-right corner of the Start screen to display the charms.2. Click Settings > Change PC Settings.
Operating systems	<p>For additional information, on:</p> <ul style="list-style-type: none">• Operating systems supported on HP workstations, go to http://www.hp.com/go/wsos.• Windows operating systems, go to http://www.microsoft.com/support.• Linux operating systems, go to http://www.hp.com/linux.

2 Workstation features

For complete and current information on supported accessories and components for your workstation, see <http://partsurfer.hp.com>.

Topics

[HP Z220 SFF Workstation components on page 8](#)

[HP Z220 CMT Workstation components on page 10](#)

[HP Z420 Workstation components on page 12](#)

[HP Z620 Workstation components on page 14](#)

[HP Z820 Workstation components on page 16](#)

[Product specifications on page 18](#)

HP Z220 SFF Workstation components

This section describes the HP Z220 Small Form Factor (SFF) Workstation components.

For complete and current information on supported accessories and components for the computer, see <http://partsurfer.hp.com>.

Z220 SFF Workstation front panel

Figure 2-1 Front panel components

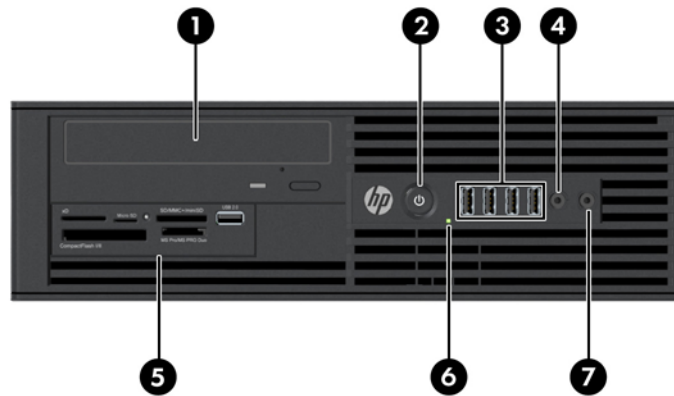







Table 2-1 Component description

1	Optical drive	5	Optional media card reader (shown) or optional second hard disk drive
2	 Power button	6	 Hard drive or optical drive activity light
3	 USB 2.0 ports (4, black)	7	 Headphones connector
4	 Microphone or headphones connector (software selectable, default mode is microphone)		

Z220 SFF Workstation rear panel

Figure 2-2 Rear panel components

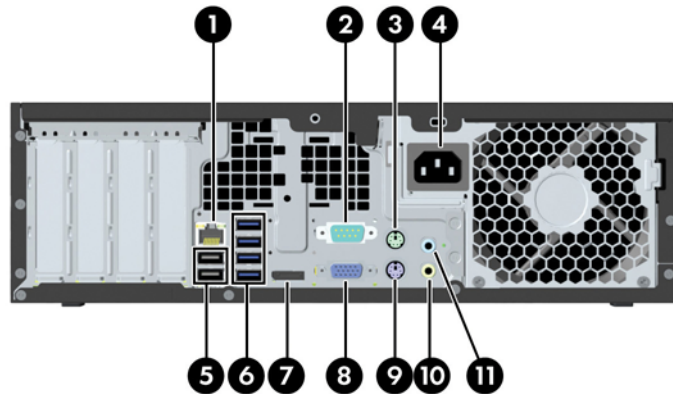













Table 2-2 Component descriptions

1		RJ-45 network connector	7		DisplayPort (DP)
2		Serial port	8		VGA (monitor) (blue)
3		PS/2 mouse connector (green)	9		PS/2 keyboard connector (purple)
4		Power cord connector	10		Audio line-out connector (green)
5		USB 2.0 ports (2) (back)	11		Audio line-in connector (blue)
6		USB 3.0 ports (4) (blue)	NOTE: The labels for the rear panel connectors use industry-standard icons and colors.		

 **NOTE:** The DP and VGA ports are not supported when the system is configured with Intel® Xeon E3-12x0 v2 processors. Also, if a discrete graphics card is installed, these ports are disabled by default.

 **NOTE:** Simultaneous usage of integrated Intel HD graphics and discrete graphics cards (in order to drive more than two displays) can be enabled using the Computer (F10) Setup Utility. However, HP recommends using only discrete graphics cards when attaching three or more displays.

HP Z220 CMT Workstation components

This section describes the HP Z220 Convertible Mini Tower (CMT) Workstation components.

For complete and current information on supported accessories and components for the computer, see <http://partsurfer.hp.com>.

HP Z220 CMT Workstation front panel

Figure 2-3 Front panel components

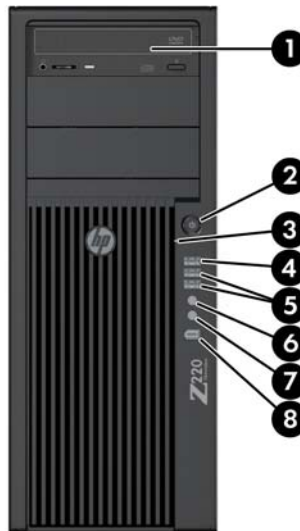









Table 2-3 Component descriptions

1	Optical drive	5	 USB 3.0 ports (2) (blue)
2	 Power button	6	 Headphone connector
3	 Hard drive activity light	7	 Microphone connector
4	 USB 2.0 ports (1) (black)	8	 1394a FireWire® connector (optional and plugged unless configured)

HP Z220 CMT Workstation rear panel

Figure 2-4 Rear panel components

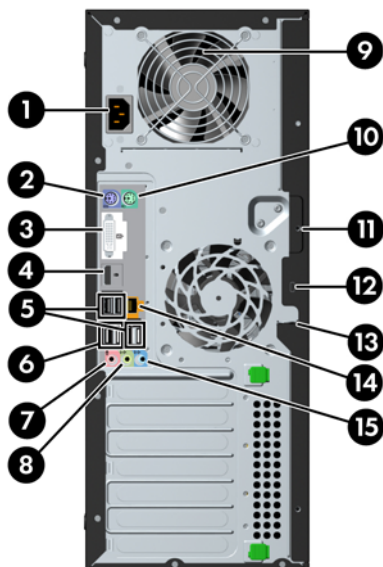













Table 2-4 Component descriptions

1	Power cord connector	9	Power supply Built-In Self Test (BIST) LED
2	 PS/2 keyboard connector (purple)	10	 PS/2 mouse connector (green)
3	 DVI-I connector	11	Universal chassis clamp opening
4	 Display Port (DP) connector	12	Cable lock slot
5	 USB 2.0 ports (4) (black)	13	Padlock loop
6	 USB 3.0 ports (2) (blue)	14	 RJ-45 network connector
7	 Microphone connector (pink)	15	 Audio line-in connector (blue)
8	 Audio line-out connector (green)	NOTE: The labels for the rear panel connectors use industry-standard icons and colors.	

 **NOTE:** The DP and DVI-I ports are not supported when the system is configured with Intel Xeon E3-12x0 v2 processors. Also, if a discrete graphics card is installed these ports are disabled by default.

 **NOTE:** Simultaneous usage of integrated Intel HD graphics and discrete graphics cards (in order to drive more than two displays) can be enabled using the Computer (F10) Setup Utility. However, HP recommends using only discrete graphics cards when attaching three or more displays.

HP Z420 Workstation components

HP Z420 Workstation front panel

Figure 2-5 Front panel components

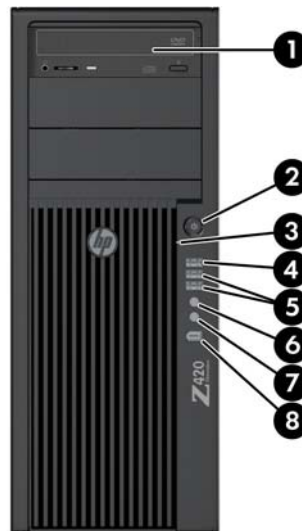

Table 2-5 Component descriptions

1	Optical drive	5		USB 3.0 ports (2, blue)
2	 Power button	6		Headphone connector
3	 Hard drive activity light	7		Microphone connector
4	 USB 2.0 port (1, black)	8		IEEE-1394a FireWire connector (optional and plugged unless configured)

HP Z420 Workstation rear panel

Figure 2-6 Rear panel components

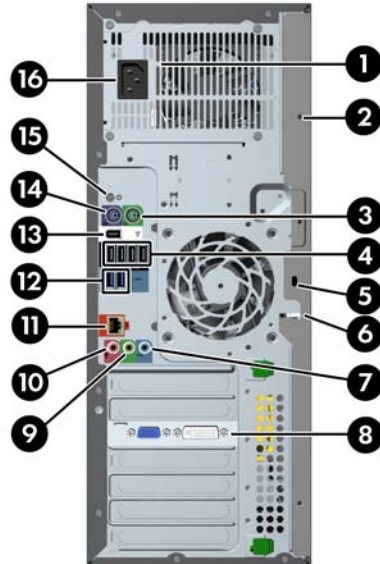











Table 2-6 Component descriptions

1	Power supply Built-In Self Test (BIST) LED	9		Audio line-out connector (green)
2	Universal chassis clamp opening	10		Microphone connector (pink)
3	 PS/2 mouse connector (green)	11		AMT-enabled RJ-45 network connector (orange)
4	 USB 2.0 ports (4, black)	12		USB 3.0 ports (2, blue)
5	Security slot	13		IEEE-1394a FireWire connector (white)
6	Padlock loop	14		PS/2 keyboard connector (purple)
7	 Audio line-in connector (blue)	15		Rear power button
8	Graphics card connector	16		Power cord connector

HP Z620 Workstation components

HP Z620 Workstation front panel

Figure 2-7 Front panel components

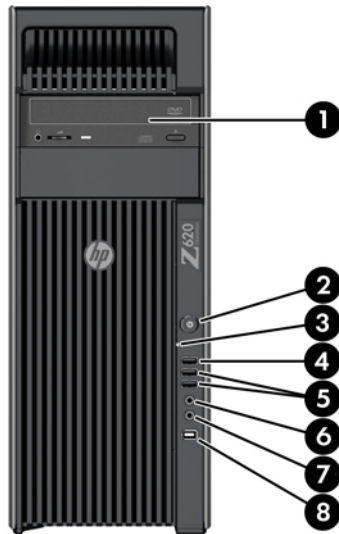

Table 2-7 Component descriptions

1	Optical drive	5		USB 3.0 ports (2, blue)
2	 Power button	6		Headphone connector
3	 Hard drive activity light	7		Microphone connector
4	 USB 2.0 port (black)	8		IEEE-1394a FireWire connector

HP Z620 Workstation rear panel

Figure 2-8 Rear panel components

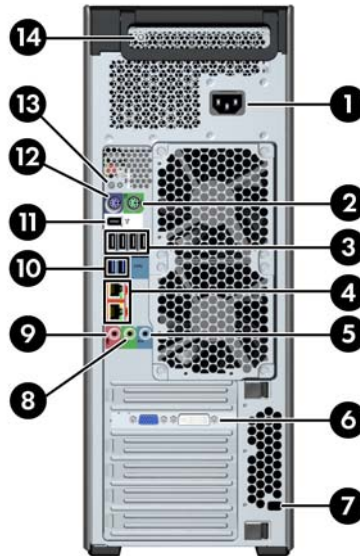











Table 2-8 Component descriptions

1	Power cord connector	8	 Audio line-out connector (green)
2	 PS/2 mouse connector (green)	9	 Microphone connector (pink)
3	 USB 2.0 ports (4, black)	10	 USB 3.0 ports (2, blue)
4	 RJ-45 network connectors (orange) <i>Bottom connector is AMT enabled</i>	11	 IEEE-1394a FireWire connector (white)
5	 Audio line-in connector (blue)	12	 PS/2 keyboard connector (purple)
6	Graphics card connector	13	 Rear power button
7	Security slot	14	Power supply Built-In Self Test (BIST) LED

HP Z820 Workstation components

HP Z820 Workstation front panel

Figure 2-9 Front panel components

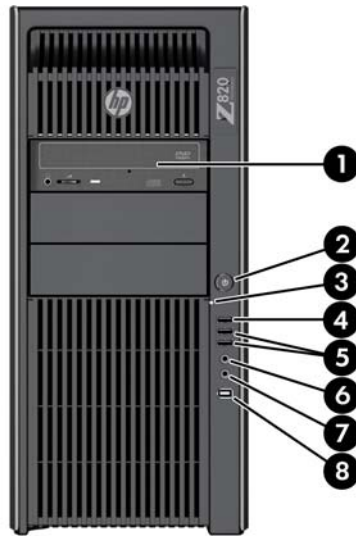

Table 2-9 Component descriptions

1	Optical drive	5		USB 3.0 ports (2, blue)
2	 Power button	6		Headphone connector
3	 Hard drive activity light	7		Microphone connector
4	 USB 2.0 port (1, black)	8		IEEE-1394a FireWire connector

HP Z820 Workstation rear panel

Figure 2-10 Rear panel components

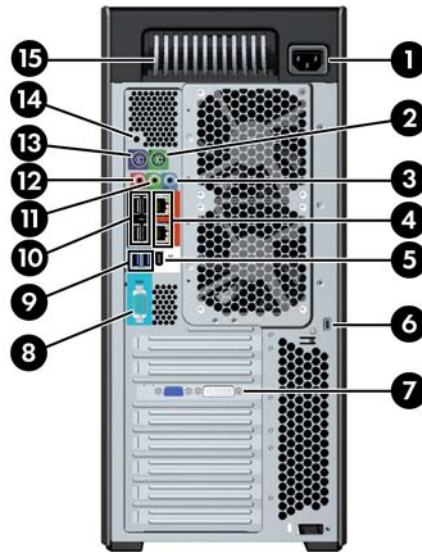













Table 2-10 Component descriptions

1	Power cord connector	9	 USB 3.0 ports (2, blue)
2	 PS/2 mouse connector (green)	10	 USB 2.0 ports (4, black)
3	 Audio line-in connector (blue)	11	 Audio line-out connector (green)
4	 RJ-45 network connectors (2, orange) <i>Top connector is AMT enabled</i>	12	 Microphone connector (pink)
5	 IEEE-1394a FireWire connector (white)	13	 PS/2 keyboard connector (purple)
6	Security slot	14	 Rear power button
7	Graphics card connector(s)	15	Power supply Built-In Self Test (BIST) LED
8	 Serial connector (teal blue)		

Product specifications

Workstation weights and dimensions

Characteristic		HP Z220 SFF	HP Z220 CMT	HP Z420	HP Z620	HP Z820
Weight	Standard configuration	7.5 kg (16.53 lb.)	11.6 kg (25.57 lb)	13.2 kg (29.10 lb)	17.9 kg (39.46 lb)	26.6 kg (58.64 lb)
	Minimum configuration	6.6 kg (14.55 lb)	10.6 kg (23.37 lb)	12.5 kg (27.56 lb)	15.5 kg (34.17 lb)	24.0 kg (52.91 lb)
	Maximum configuration	8.4 kg (18.52 lb)	14.7 kg (32.41 lb)	17.7 kg (39.02 lb)	22.6 kg (49.82 lb)	32.0 kg (70.55 lb)
Chassis dimensions <i>Tower configuration</i>	Height	33.8 cm (13.3 in)	44.8 cm (17.6 in)	44.76 cm (17.62 in)	44.45 cm (17.50 in)	44.4 cm (17.5 in)
	Width	10.0 cm (3.95 in)	17.8 cm (7.0 in)	17.78 cm (7.00 in)	17.15 cm (6.75 in)	20.3 cm (8.0 in)
	Depth	38.1 cm (15.0 in)	45.4 cm (17.9 in)	44.50 cm (17.53 in)	46.48 cm (18.30 in)	52.5 cm (20.7 in)
Chassis dimensions <i>Converted desktop configuration</i>	Height	10.0 cm (3.95 in)	17.8 cm (7.0 in)	17.78 cm (7.00 in)	17.15 cm (6.75 in)	20.3 cm (8.0 in)
	Width	33.8 cm (13.3 in)	44.8 cm (17.6 in)	44.76 cm (17.62 in)	44.45 cm (17.50 in)	44.4 cm (17.5 in)
	Depth	38.1 cm (15.0 in)	45.4 cm (17.9 in)	44.50 cm (17.53 in)	46.48 cm (18.30 in)	52.5 cm (20.7 in)

Environmental specifications

Table 2-11 HP Workstation environmental specifications

Characteristic	HP Z220 SFF, Z220 CMT, Z420, Z620, and Z820 Workstations
Temperature	<p>Operating: 5°C to 35°C (40°F to 95°F)</p> <p>Non-operating: -40°C to 60°C (-40°F to 140°F)</p> <p>NOTE: Derate by 1°C (1.8°F) for every 305 m (1,000 ft) altitude over 1,524 m (5,000 ft).</p>
Humidity	<p>Operating: 8% to 85% relative humidity, non-condensing</p> <p>Non-operating: 8% to 90% relative humidity, non-condensing</p>
Altitude	<p>Operating: 0 to 3,048 m (10,000 ft)</p> <p>Non-operating: 0 to 9,144 m (30,000 ft)</p>
Shock	<p>Operating: ½-sine: 40g, 2-3ms</p> <p>Non-operating:</p> <ul style="list-style-type: none"> • ½-sine: 160 cm/s, 2-3ms (~100g) • square: 422 cm/s, 20g <p>NOTE: Values represent individual shock events and do not indicate repetitive shock events.</p>
Vibration	<p>Operating Random: 0.5g (rms), 5-300 Hz</p> <p>Non-Operating: random: 2.0g (rms), 10-500 Hz</p> <p>NOTE: Values do not indicate continuous vibration.</p>

3 Setting up the workstation

This chapter describes how to set up your workstation.

Topics

[Ensuring proper ventilation on page 20](#)

[Setup procedures on page 22](#)

[Adding monitors on page 23](#)

[Converting to desktop configuration \(Z220 CMT and Z420\) on page 29](#)

Ensuring proper ventilation

Proper ventilation for the system is important for workstation operation. Follow these guidelines:

- Operate the workstation on a sturdy, level surface.
- Provide at least 15.24 cm (6 inches) of clearance at the front and back of the workstation. (Workstation models vary.)

Figure 3-1 Proper workstation ventilation

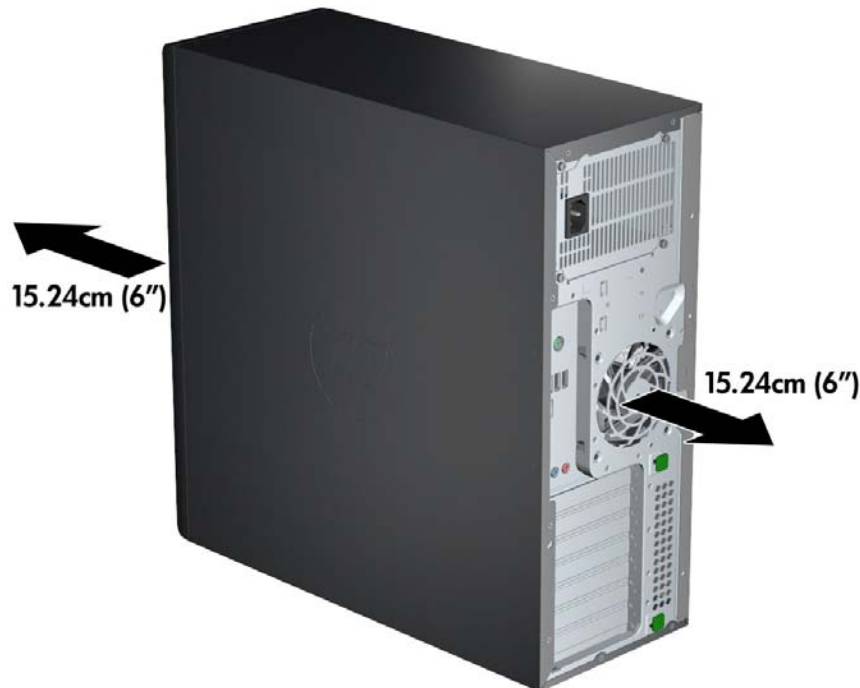

- Ensure that the ambient air temperature falls within the environmental specifications listed in this document.

 **NOTE:** The ambient upper limit of 35°C (95°F) only good up to 1524 m (5000 ft) elevation. There is a 1°C (33.8°F) per 304.8 m (1000 ft) derating above 1524 m (5000 ft). So, at 3,048 m (10,000 ft), the upper ambient air temperature limit is 30°C (86°F).

- For cabinet installation, ensure adequate cabinet ventilation and ensure that the ambient temperature within the cabinet does not exceed specified limits.
- Never restrict the incoming or outgoing airflow of the workstation by blocking any vents or air intakes, as shown in the following figure.

Figure 3-2 Proper workstation placement

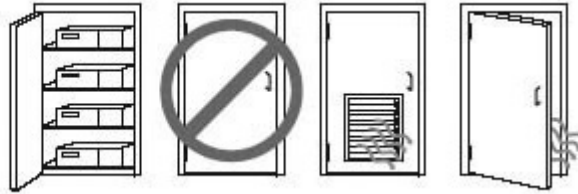

Setup procedures

⚠ WARNING! To reduce the risk of electric shock or damage to your equipment, observe these practices:

- Plug the power cord into an AC outlet that is easily accessible.
- Disconnect power from the computer by unplugging the power cord from the AC outlet (not by unplugging the power cord from the computer).
- Plug the cord into a grounded (earthed) three-pin outlet. Do not disable the power cord grounding pin (for example, by attaching a two-pin adapter). The grounding pin is an important safety feature.

📝 NOTE: An HP Z820 Workstation with a 1125 W power supply might require more power than the typical office environment can supply. For details, see the *Site Preparation Guide* for the workstation at http://www.hp.com/support/workstation_manuals.

To set up the workstation:

1. Connect the mouse, keyboard, and power cord to the workstation.
2. Connect the monitor to the workstation.
3. Plug the workstation power cord and monitor power cord into an AC outlet.
4. Connect other peripheral components (such as a printer) according to the instructions included with the device.
5. Connect an Ethernet cable to the computer and to a network router or LAN device.

Figure 3-3 Connecting the workstation

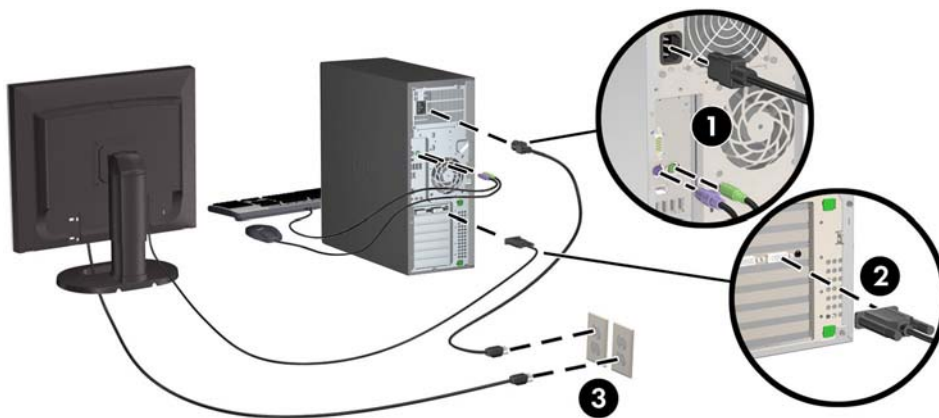

Adding monitors

Planning for additional monitors

All graphics cards provided with HP Z series Workstations support two simultaneous display monitors (see [Connecting and configuring monitors on page 26](#)). Cards that support more than two monitors are available. The process for adding monitors depends on your graphics card(s) and the type and number of monitors you add.

Use this process to plan for adding more monitors.

1. Assess your monitor needs:

- Determine how many monitors you require.
- Determine the kind of graphics performance you want.
- Note the type of graphics connector used by each monitor. HP provides graphics cards with DisplayPort (DP) and DVI interfaces, but you can use adapters and third-party cards to interface to other graphics formats, including DVI-I, HDMI, or VGA.

 **TIP:** Some adapters for older legacy hardware may cost more than others. You may want to compare the cost of acquiring adapters with the cost of getting a newer monitor that doesn't need adapters.

2. Determine if you need additional graphics cards:

- Consult the graphics card documentation to determine how many monitors you can connect to the card.

You may need to acquire adapters to match the card output to the monitor connector. (See [Matching graphics cards to monitor connectors on page 25](#).)

- If necessary, plan to acquire a new graphics card to drive additional monitors.
- The maximum number of monitors that a graphics card supports depends on the card. Most cards provide outputs for two monitors. Some provide three or four outputs.

 **NOTE:** Monitors with resolutions above 1920 x 1200 pixels at 60 Hz require a graphics card with either Dual Link DVI (DL-DVI) or DisplayPort output. To get native resolution with DVI, you must use a DL-DVI cable, not standard DVI-I or DVI-D cables.

HP computers do not support all graphics cards. Make sure a new graphics card is supported before purchasing it. See [Finding supported graphics cards on page 25](#).

Many graphics cards provide more than two monitor outputs but limit you to using only two at a time. Consult the graphics card documentation or look up information on the card according to the procedure in [Finding supported graphics cards on page 25](#).

Some graphics cards support multiple monitors by multiplexing the monitor signal across multiple outputs. This might reduce graphics performance. Consult the graphics card documentation or look up information on the card according to the procedure in [Finding supported graphics cards on page 25](#).

Make sure the card outputs match the input required by the monitors. (See [Identifying monitor connection requirements on page 25](#).)

The different models of HP Z series Workstations have different limits on the mechanical size, data speed, and power available for additional graphics cards. In addition, the usual practical limit for graphics cards is two per computer. Refer to the *Maintenance and Service Guide* for expansion card slot identification to make sure a new graphics card will work for your computer.

3. If you want to add a new graphics card or cards:

- a. Determine which graphics card HP supports that will best fit your needs in terms of number of monitors, compatibility with the monitors you plan to use, and performance. See [Finding supported graphics cards on page 25](#).
- b. Make sure you have the correct drivers for the card.
- c. Install the graphics card according to the video instructions for your workstation at <http://www.hp.com/go/sml>.
- d. Configure the monitor. For details, refer to Microsoft® Help or to <http://www.microsoft.com>, or to your Linux Help website.

 **TIP:** To simplify troubleshooting of possible problems, enable the monitors one at a time: enable the first monitor and make sure it works properly before enabling the next monitor.





Finding supported graphics cards

To find information about graphics cards supported for your workstation:

1. Go to <http://www.hp.com/go/quickspecs>.
2. In the left navigation bar under **QuickSpecs**, click on your country, then select **Workstations**.
3. Choose your model to view the specifications.
4. Click on the link for **Technical Specifications-Graphics**. This displays expanded technical information for supported graphics cards, including how many monitors the card supports, connectors, power consumption, drivers, and other details.

Matching graphics cards to monitor connectors

The following table describes monitor configuration scenarios.

Graphics card interface connector	Monitor connector				
	VGA	DVI	Dual Link DVI	DisplayPort (DP)	HDMI
DISPLAYPORT 	DisplayPort to VGA adapter (sold separately)	DP to DVI adapter	DP to DL DVI adapter	DP cable	DP to HDMI adapter
DVI—I (WHITE) 	DVI to VGA adapter or DVI-I cable	DVI-D cable	DL DVI cable	N/A	N/A
VGA (BLUE) 	No adapter required	DVI-I to VGA adapter is required	N/A	N/A	N/A
DMS-59 	DMS-59 to VGA adapter	DMS-59 to DVI adapter	N/A	DMS-59 to DP adapter	N/A

* This interface is a dual-monitor graphics interface card that supports two VGA or two DVI monitors.

 **NOTE:** HP graphics cards include monitor cable adapters unless otherwise indicated.

DisplayPort cards have the highest performance; VGA graphics cards have the lowest.

Identifying monitor connection requirements

The following are various scenarios for connecting monitors. (See [Matching graphics cards to monitor connectors on page 25](#) for more information about the different graphic cards):

- **Graphics card with DisplayPort output** — If the graphics card has four DisplayPort outputs, you can connect a monitor to each connector. Use the proper adapters if required.
- **Graphics card with DVI output** — If you have a PCIe graphics card with two DVI outputs, you can connect a monitor to each connector. Use the proper adapters if required.

 **NOTE:** Models that have only one DVI port always have a second graphics output option (Display Port or VGA).

Many graphics cards provide more than two monitor outputs but limit you to using only two at a time. Consult the graphics card documentation or look up information on the card according to the procedure in [Matching graphics cards to monitor connectors on page 25](#).

On a system with two DVI connections, port number 1 provides the primary display, which is where the BIOS POST screen appears after a system boot. (Usually this is the lower of the two outputs. Only one card is used during BIOS POST, although you can change this in the BIOS settings.)

- **Graphics card with VGA and DL-DVI output** — If the workstation does not have a PCIe graphics card, but has one or more SVGA *and/or* DL-DVI outputs, you can connect a monitor to each output.
- **Graphics card with DMS-59 output** — If the workstation has a PCIe graphics card with a DMS-59 output receptacle, use the appropriate adapter to connect your monitor.

Adapters are available to connect the DMS-59 output to two DVI or two VGA monitors.

Connecting and configuring monitors

 **NOTE:** The graphic cards that HP supports typically allow at least two monitors, as shown in this section; some supported cards allow more monitors. Refer to the graphics card documentation for details.

1. Connect the monitor cable adapters (1) (if required) to the workstation, then connect the appropriate monitor cables to the adapters (2) or directly to the graphics card.

Figure 3-4 Connecting the cables to the workstation



2. Connect the other ends of the graphics cables to the monitors.

Figure 3-5 Connecting cables to the monitors

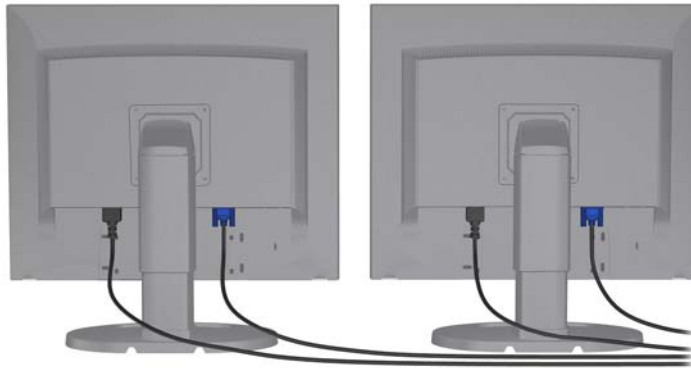



3. Connect one end of the monitor power cord to the monitor and the other end to a grounded power outlet.
4. Configure the monitor. For details, refer to Microsoft Help or to <http://www.microsoft.com>, or to your Linux Help or website.

Using a third-party graphics configuration utility

Third-party graphics cards may include a monitor configuration utility. Upon installation, this utility is integrated into Windows. You can select the utility and use it to configure multiple monitors with your workstation.

Refer to your graphics card documentation for details.

 **NOTE:** Some third-party configuration utilities require that you enable the monitors in Windows before using the configuration tool. Refer to your graphics card documentation for more information.

 **NOTE:** Monitor configuration utilities are also often available on the HP support website.

Customizing the monitor display (Windows)

You can manually select or change the monitor model, refresh rates, screen resolution, color settings, font sizes, and power management settings.

- To change display settings in Windows 7, right-click a blank area on the desktop, and then click **Screen Resolution**.
- To change display settings in Windows 8, point to the upper-right or lower-left corner of the Start screen to display the charms, and then click **Settings > Control Panel > Appearance and Personalization > Adjust Screen Resolution**.
- For Windows 8, you can also change the display settings by pointing to the upper-right or lower-left corner of the Start screen to display the Charms menu, and then clicking **Search > Settings**, typing `resolution` in the **Settings** search field, and clicking **Adjust Screen Resolution**.

For more information about customizing your monitor display, refer to:

- Online documentation provided with the graphics controller utility
- Documentation included with your monitor

Converting to desktop configuration (Z220 CMT and Z420)

This workstation can be operated in mini-tower or desktop configuration. Follow these steps to convert to desktop configuration:

 **NOTE:** See a video of this task at <http://www.hp.com/go/sml>.

1. Prepare the workstation for component installation.
2. Remove the front bezel from the workstation.
3. Press gently on the edges of the optical drive bay filler panel and remove it from the front bezel.

Figure 3-6 Removing the ODD bay filler panel

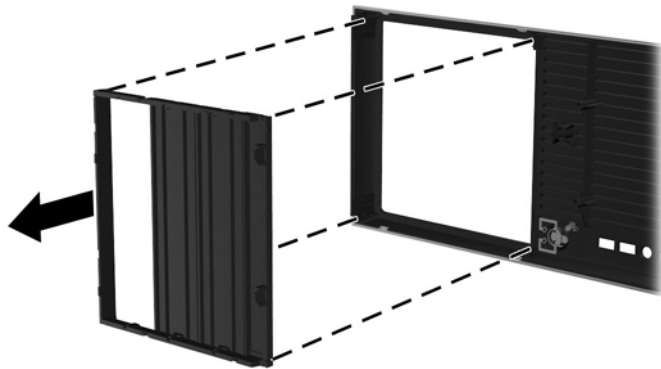

4. Rotate the filler panel 90 degrees to a horizontal position.
5. Align the slots in the filler panel frame with the tabs in the front bezel. Press the optical drive filler panel back into the front bezel until it snaps into place.

Figure 3-7 Installing the ODD bay filler panel

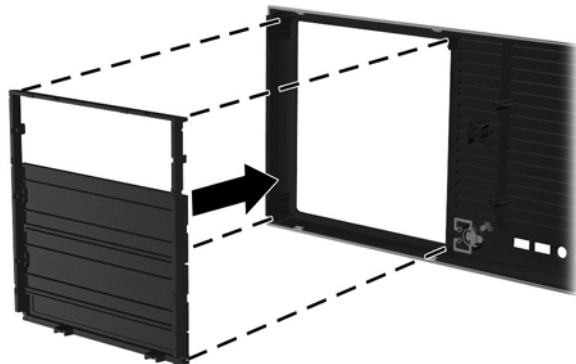

6. On the back of the front bezel, squeeze the HP logo mounting tabs (1) and press the logo outward (2).

Figure 3-8 Rotating the HP logo

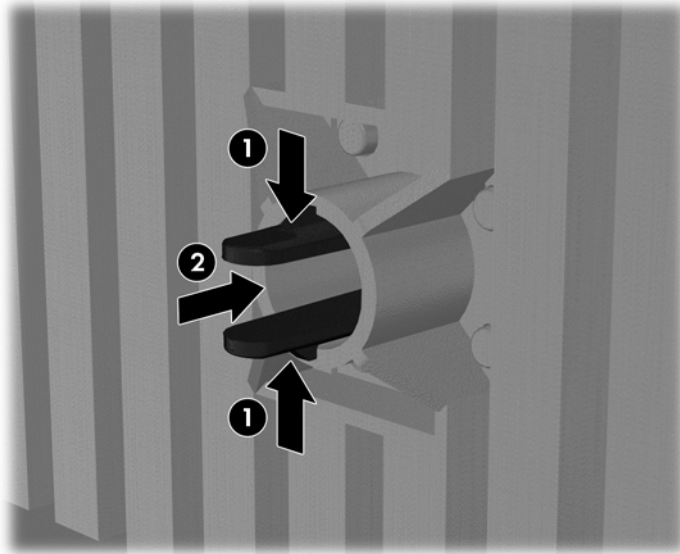

Rotate the HP logo 90 degrees counterclockwise, then release the logo and press it back into place.

7. Remove the EMI filler panels and optical disk drive from the chassis.
8. Rotate the EMI filler panels and optical drive 90 degrees, then reinstall them.

Figure 3-9 Reinstalling the optical drive



9. Replace the front bezel and the side access panel.

Installing optional components

Depending on the workstation model, additional components (such as memory, hard drives, optical drives, PCIe cards, or second processor) can be installed on your workstation.

- To view component installation videos, go to <http://www.hp.com/go/sml>.
- For installation guidelines and technical information, refer to the *Maintenance and Service Guide* for your workstation at http://www.hp.com/support/workstation_manuals.

Security

Some HP workstations have a lock on the side access panel. The key for this lock is shipped attached to the back panel of the workstation chassis.

Additional security features reduce the risk of theft and warn of chassis intrusion. Refer to the *Maintenance and Service Guide* for your workstation at http://www.hp.com/support/workstation_manuals for information about additional hardware and software security features available for your system.

Product recycling

HP encourages customers to recycle used electronic hardware, HP original print cartridges, and rechargeable batteries.

For information about recycling HP components or products, see <http://www.hp.com/go/recycle>.

4 Setting up, backing up, restoring, and recovering Windows 7

This chapter provides setup and update information for the Windows 7 operating system. It includes these topics:

- [Setting up the Windows 7 operating system](#)
- [Backing up, restoring, and recovering Windows 7](#)

 **CAUTION:** Do not add optional hardware or third-party devices to the HP workstation until the operating system is successfully installed. Adding hardware might cause errors and prevent the operating system from installing correctly.

 **NOTE:** After you set up the operating system, be sure that the latest BIOS, drivers, and software updates are installed on the workstation. See [Updating the workstation on page 47](#).

Setting up the Windows 7 operating system

 **CAUTION:** After installation has started, do *not* turn off the workstation until the process is complete. Turning off the workstation during installation can damage the installation and operation of the software.

For complete installation and configuration instructions, go to <http://windows.microsoft.com/en-US/windows7/help>. Additional information is available in the Windows 7 online Help after you successfully install the operating system.

Installing or upgrading device drivers

You must install the appropriate device drivers before you install hardware devices. Follow the installation instructions that came with each device. For optimum performance, your operating system must have the most recent updates, patches, and service packs. See <http://www.hp.com> for HP-qualified drivers. For additional driver and software update information, see [Updating the workstation on page 47](#).

Transferring files and settings

The Windows operating system offers data migration tools that help you select and transfer files and data from one Windows-based workstation to another.

For information about these tools, go to <http://www.microsoft.com>.

Backing up, restoring, and recovering Windows 7

Your workstation includes tools provided by HP and Windows to help you safeguard your information and retrieve it if you ever need to. These tools will help you return your workstation to a proper working state or even back to the original factory state, all with simple steps.

This section provides information about the following processes:

- Creating backups
- Restoring and recovering your system

 **NOTE:** For more details about the Windows Backup and Restore tools provided, see Help and Support. To access Help and Support: select **Start**, and then select **Help and Support**.

Recovery after a system failure is only as good as your most recent backup.

1. After you successfully set up the workstation, use Windows tools to create recovery media. In Windows 7, select **Start > Control Panel > System and Security > Backup and Restore > Create a system image**.
2. As you add hardware and software programs, create system restore points. A system restore point is a snapshot of certain hard drive contents saved by Windows System Restore at a specific time. A system restore point contains information that Windows uses, such as registry settings. Windows creates a system restore point for you automatically during a Windows update and during other system maintenance activities (such as a software update, security scanning, or system diagnostics). You can also manually create a system restore point at any time. For more information and steps for creating specific system restore points, see Help and Support. To access Help and Support: select **Start**, and then select **Help and Support**.
3. As you add photos, video, music, and other personal files, create a backup of your personal information. If files are accidentally deleted from the hard drive and they can no longer be restored from the Recycle Bin, or if files become corrupted, you can restore the files that you backed up. In case of system failure, you can use the backup files to restore the contents of your workstation. See [Backing up your information on page 33](#).

 **NOTE:** HP recommends that you print the recovery procedures and save them for later use, in case of system instability.

Backing up your information

 **NOTE:** Windows includes the User Account Control feature to improve the security of your workstation. You may be prompted by User Account Control for your permission or password when you perform certain tasks. To continue a task, select the appropriate option. For information about User Account Control, see Help and Support: select **Start** and then select **Help and Support**.

You should create your initial backup immediately after initial system setup. As you add new software and data files, you should continue to back up your system on a regular basis to maintain a reasonably current backup. Your initial and subsequent backups allow you to restore your data and settings if a failure occurs.

 **NOTE:** For detailed instructions on various backup and restore options, perform a search for these topics in Help and Support. To access Help and Support: select **Start** and then select **Help and Support**.

You can back up your information to an optional external hard drive, a network drive, or discs.

Note the following when backing up your information:

- Store personal files in the Documents library, and back it up regularly.
- Back up templates that are stored in their associated directories.
- Save customized settings that appear in a window, toolbar, or menu bar by taking a screen shot of your settings. The screen shot can be a time-saver if you have to reset your preferences.
- When backing up to discs, number each disc after removing it from the drive.

To create a backup using Windows Backup and Restore:

 **NOTE:** The backup process may take over an hour, depending on file size and the speed of the workstation.

1. Select **Start > All Programs > Maintenance > Backup and Restore**.
2. Follow the on-screen instructions to set up your backup.

System Restore

If you have a problem that might be due to software that you installed on your workstation, use System Restore to return the workstation to a previous restore point. You can also set restore points manually.

 **NOTE:** Always use this System Restore procedure before you use the System Recovery feature.

To start System Restore:

1. Close all open programs.
2. Select **Start**, select **Computer**, and then select **Properties**.
3. Select **System protection > System Restore > Next**, and then follow the on-screen instructions.

System Recovery

 **CAUTION:** This procedure will delete all user information. To prevent loss of information, be sure to back up all user information so you can restore it after recovery.

Always use the System Restore procedure before you use the System Recovery program. See [System Restore on page 34](#).

System Recovery completely erases and reformats the hard disk drive, deleting all data files that you have created, and then reinstalls the operating system, programs, and drivers. However, you must reinstall any software that was not installed on the workstation at the factory. This includes software that came on media included in the workstation accessory box, and any software programs that you have installed.

You can order a recovery media set from support. For U.S. support, go to <http://www.hp.com/support>. For worldwide support, go to <http://www8.hp.com/us/en/contact-hp/ww-contact-us.html>. You can also order the recovery media set by calling support.

 **NOTE:** Some features might not be available on systems that are shipped without a Windows operating system.

You must choose one of the following methods to perform a System Recovery:

- Recovery image — Run System Recovery from a recovery image stored on your hard disk drive. The recovery image is a file that contains a copy of the original factory-shipped software. To perform a System Recovery from a recovery image, see [System Recovery from a recovery partition image on page 35](#).
- Recovery media — Run System Recovery from recovery media that you have purchased separately.

System Recovery from a recovery partition image

 **CAUTION:** System Recovery deletes all data and programs that you have created or installed.

A Windows system from the HP factory ships with a recovery partition. You can use the recovery partition to recover the factory operating system.

1. Turn off the workstation. If necessary, press and hold the power button until the workstation turns off.
2. Disconnect all peripheral devices from the workstation except the monitor, keyboard, and mouse.
3. Press the power button to turn on the workstation.
4. As soon as you see the HP logo screen, repeatedly press the **F11** key on your keyboard until the *Windows is Loading Files...* message appears on the screen.
5. At the HP Recovery Manager screen, follow the on-screen instructions to continue.
6. When Windows has loaded, shut down the workstation, reconnect all peripheral devices, and then turn the workstation back on.

Using HP Recovery Disc operating system discs

 **CAUTION:** Using a Windows 7 operating system DVD completely erases hard drive contents and reformats the hard drive. All files that you have created and any software that you have installed on the workstation are permanently removed. When reformatting is complete, the recovery process helps you restore the operating system, as well as the original drivers. Software that came with the system can be downloaded at <http://www.hp.com>.

Use the steps provided in this section if you ordered a Windows 7 operating system DVD and Driver DVD.

To order a Windows 7 operating system DVD and Driver DVD, go to the HP website. For U.S. support, go to <http://www.hp.com/cgi-bin/hpsupport/index.pl>. For worldwide support, go to <http://www8.hp.com/us/en/contact-hp/ww-contact-us.html>. You can also order the DVDs by calling support.

To initiate recovery using a Windows 7 operating system DVD:

 **NOTE:** This recovery process takes several minutes.

1. Backup all personal files.
2. Restart the workstation, and then insert the Windows 7 operating system DVD into the optical drive.

 **NOTE:** If the workstation does not boot to the DVD, restart the workstation and press **Esc** as the workstation is powering on to see the startup menu. Use the arrow keys to select the boot menu and press **enter**. Use the arrow keys to select the location where the recovery DVD is inserted to boot from that device. Booting the DVD from UEFI Boot sources will result in a GPT boot partition. Booting from Legacy Boot sources will result in an MBR boot partition.

3. When prompted, press any keyboard key.
4. Follow the on-screen instructions.

After the operating system installation has completed:

1. Eject the Windows 7 operating system DVD, and insert the Driver DVD once the system is booted into the OS for the first time.

 **NOTE:** The Driver DVD will load prerequisite software, and then allow you to load drivers.

2. Install the Hardware Enabling Drivers. HP recommends installing all available drivers.
3. You can download applications that came with the workstation at <http://www.hp.com>.

 **NOTE:** For more information on using the restore media, refer to the white paper “Restoring Windows 7 on the HP Z420, Z620 and Z820: Using HP OS DVD and Driver DVD.” This white paper can be found on <http://www.hp.com/support>.

5 Setting up and restoring Windows 8

This chapter provides setup and update information for the Windows 8 operating system. It includes these topics:

Topics

[Additional information on page 37](#)

[Backup and recovery in Windows 8 on page 38](#)

 **NOTE:** After you set up the operating system, you should make sure that the latest BIOS, drivers, and software updates are installed on the workstation. Refer to the chapter on updating the workstation.

 **CAUTION:** Do not add optional hardware or third-party devices to the HP workstation until the operating system is successfully installed. Adding hardware might cause errors and prevent the operating system from installing correctly.

Additional information

Additional information is available in the online help after you customize the operating system.

Setting up the Windows 8 operating system

The first time you turn on the computer you can customize the operating system. If you are connected to the Internet, Microsoft activates your operating system. This process takes about 15 to 30 minutes. Carefully read and follow the instructions on the screen.

We recommend that you register your computer with HP; so you can receive important software updates, facilitate support questions, and sign up for special offers. You can register your computer with HP using the **Register with HP** app on the Start screen.

 **CAUTION:** After the initial setup process has begun, **DO NOT TURN OFF THE COMPUTER UNTIL THE PROCESS IS COMPLETE.** Turning off the computer during this process may damage the software that runs the computer or prevent its proper installation.

 **NOTE:** Windows includes the User Account Control feature to improve the security of your computer. You may be prompted for your permission or password for tasks such as installing software, running utilities, or changing Windows settings. Refer to Help and Support for more information. From the Start screen, type `help`, and then select **Help and Support**.

Downloading Windows 8 updates

Microsoft may release updates to the operating system. To help keep the computer running optimally, HP recommends checking for the latest updates during the initial installation and periodically throughout the life of the computer.

Run Windows Update as soon as possible after you set up your computer.

1. Point to the upper-right or lower-right corner of the Start screen to display the charms.
2. Click **Settings > Change PC Settings > Windows Update**.
3. Run Windows Update monthly thereafter.

Backup and recovery in Windows 8

To protect your information, use Windows Backup and Restore to back up individual files and folders, back up your entire hard drive, create system repair media, or create system restore points. In case of system failure, you can use the backup files to restore the contents of your computer.

From the Start screen, type `restore`, click **Settings**, and then select from the list of displayed options.

 **NOTE:** For detailed instructions on various backup and restore options, perform a search for these topics in Help and Support. From the Start screen, type `help`, and then select **Help and Support**.

In case of system instability, HP recommends that you print the recovery procedures and save them for later use.

Backing up your information

Recovery after a system failure is as good as your most recent backup. You should create system repair media and your initial backup immediately after initial system setup. As you add new software and data files, you should continue to back up your system on a regular basis to maintain a reasonably current backup. The system repair media is used to start up (boot) the computer and repair the operating system in case of system instability or failure. Your initial and subsequent backups allow you to restore your data and settings if a failure occurs.

Type `backup` on the Start screen, click **Settings**, and then select **Save backup copies of your files with File History**.

You can back up your information to an optional external hard drive, or a network drive.

Note the following when backing up:

- Store personal files in the Documents library, and back it up regularly.
- Backup templates that are stored in their associated programs.
- Save customized settings that appear in a window, toolbar, or menu bar by taking a screen shot of your settings. The screen shot can be a time-saver if you have to reset your preferences.

To create a backup using Windows Backup and Restore:

 **NOTE:** The backup process may take over an hour, depending on file size and the speed of the computer.

1. From the Start screen, type `backup`, click **Settings**, and then select from the list of displayed options.
2. Follow the on-screen instructions to set up your backup, create a system image, or create system repair media.

Performing a system recovery

In case of system failure or instability, the computer provides the following tools to recover your files:

- Windows recovery tools: You can use Windows Backup and Restore to recover information you have previously backed up. You can also use Windows Automatic Repair to fix problems that might prevent Windows from starting correctly.
- The **F11** recovery tools: You can use the **F11** recovery tools to recover your original hard drive image. The image includes the Windows operating system and software programs installed at the factory.

 **NOTE:** If you are unable to boot (start up) your computer and you cannot use the system repair media you previously created, you must purchase Windows 8 operating system media to reboot the computer and repair the operating system. For additional information, see [Using HP Windows 8 restore media \(purchased separately\) on page 41](#).

Using the Windows recovery tools

Recover information you previously backed up:

To recover your information using Automatic Repair, follow these steps:

 **CAUTION:** Some Automatic Repair options will completely erase and reformat the hard drive. For additional information go to Help and Support. From the Start screen, type `help`, and then select **Help and Support**.

1. If possible, back up all personal files.
2. If possible, check for the presence of the HP Recovery partition and the Windows partition:
From the Start screen, type `e`, and then click **Windows Explorer**.

– or –

From the Start screen, type `c`, and then select **Computer**.

 **NOTE:** If the Windows partition and the HP Recovery partition are not listed, you must recover your operating system and programs using the Windows 8 operating system media and the *Driver Recovery* media (both purchased separately). For additional information, see [Using HP Windows 8 restore media \(purchased separately\) on page 41](#).

3. If the Windows partition and the HP Recovery partition are listed, restart the computer after Windows has loaded, and then press and hold **Shift** while clicking **Restart**.

 **NOTE:** If the computer fails to boot to Windows after several attempts, the system will boot to the Windows Recovery Environment by default.

4. Select **Troubleshoot**, select **Advanced Options**, and then select **Automatic Repair**.
5. Follow the on-screen instructions.

 **NOTE:** For additional information on recovering information using the Windows tools, perform a search for these topics in Help and Support. From the Start screen, type `help`, and then select **Help and Support**.

Using F11 recovery tools

 **CAUTION:** Using **F11** completely erases hard drive contents and reformats the hard drive. All files that you have created and any software that you have installed on the computer are permanently removed. The **F11** recovery tool reinstalls the operating system and HP programs and drivers that were installed at the factory. Software not installed at the factory must be reinstalled.

To recover the original hard drive image using **F11**:

1. If possible, back up all personal files.
2. Restart the computer, and then press **esc** while the company logo is displayed. The computer Startup Menu displays.
3. Press **F11** to select the System Recovery option.
4. Choose your keyboard localization.
5. On the Choose an option menu, select **Troubleshoot**.
6. On the Troubleshoot menu, choose either **Refresh your PC** to repair the OS or **Reset your PC** to completely reinstall the OS.
7. Follow the on-screen instructions.

 **NOTE:** If the F11 System Recovery does not start, you must recover your operating system and programs using the Windows 8 Restore Media (purchased separately). For additional information, see [Using HP Windows 8 restore media \(purchased separately\) on page 41](#).

Using HP Windows 8 restore media (purchased separately)

To order HP Windows 8 restore media, go to <http://www.hp.com/support>, select your country or region, and follow the on-screen instructions. You can also order the media by calling support.

 **CAUTION:** Using HP Windows 8 restore media completely erases hard drive contents and reformats the hard drive. All files that you have created and any software that you have installed on the computer are permanently removed. When reformatting is complete, the recovery process helps you restore the operating system, as well as drivers, software, and utilities.

To initiate recovery using HP Windows 8 restore media:

 **NOTE:** This process takes several minutes.

1. If possible, back up all personal files.
2. Insert the Windows 8 OS DVD.
3. Restart the computer, and then follow the instructions provided with the Windows 8 operating system media to install the operating system.
4. When prompted, press any keyboard key.
5. Follow the on-screen instructions.

After the operating system install is completed:

1. Remove the Windows 8 operating system media, and then insert the *Driver Recovery* media.
2. Install the Hardware Enabling Drivers first, and then install Recommended Applications.

6 Setting up and restoring Linux

HP offers a variety of Linux solutions for HP workstation customers:

- HP certifies and supports Red Hat Enterprise Linux (RHEL) on HP workstations.
- HP certifies and supports SUSE® Linux Enterprise Desktop (SLED) on HP workstations.
- HP offers a SLED 11 preload on some Z series Workstations.

This chapter describes how to set up and restore the Linux® operating system. It includes these topics:

Topics
HP Installer Kit for Linux (HPIKL) on page 43
Setting up Red Hat Enterprise Linux on page 43
Setting up SUSE Linux Enterprise Desktop (SLED) on page 45
Proprietary graphics drivers on page 46

 **NOTE:** After you set up the operating system, make sure the latest BIOS, drivers, and software updates are installed. Refer to the chapter on updating the workstation.

 **CAUTION:** Do not add optional hardware or third-party devices to the workstation until the operating system is successfully installed. Adding hardware might cause errors and prevent the operating system from installing correctly.

HP Linux Support Matrix

Not all release streams are supported on particular platforms. To find out which streams are supported on your workstation, refer to the *Linux certification and support matrix*.

1. Go to <http://www.hp.com/linux>.
2. In the **Platforms** tab, select **HP Workstations**.
3. Select **Certification Matrix**.
4. Go to the **Red Hat** or **SUSE** tab.

HP Installer Kit for Linux (HPIKL)

The HP Installer Kit for Linux helps users install certified versions of RHEL or SLED on HP workstations. It is available as an operating system option on all HP workstations. The kit:

- Contains tested drivers that augment and/or replace those found in RHEL or SLED to enable proper use and behavior on HP workstations.
- Does **not** include Linux operating system, which must be purchased separately from Red Hat or SUSE. To view supported configurations and operating systems, go to http://www.hp.com/support/linux_hardware_matrix.

The HPIKL option includes a FreeDOS preload. This operating system option accommodates those who have a customized Linux distribution, or who have a licensed version of RHEL or SLED and would like to install the HP-recommended driver additions.

The kit also can be downloaded:

1. Go to http://www.hp.com/support/workstation_swdrivers.
2. Select your workstation model.
3. Select the desired operating system.
4. Select your software/driver language, and then click the **Software** quick jump link.
5. Click the **Obtain Software** link for the appropriate package (typically the most recent revision).
6. Click **I Agree** to accept the terms of the license agreement.
7. Download the software ISO image and save it on a disc. This disk is your *HP driver disc*.

Setting up Red Hat Enterprise Linux

HP Z series Workstations are certified and supported on RHEL streams appropriate to the hardware technology.

- For details of RHEL support for a particular platform, see the *Hardware Support Matrix for HP Linux Workstations* at http://www.hp.com/support/linux_hardware_matrix.
- For information about Red Hat certifications on HP workstations, go to <https://hardware.redhat.com>.

HPIKL driver disc

Recent versions of Red Hat Linux typically require only driver updates with minor fixes to support HP workstations. These releases can usually be supported with the HPIKL driver disc, which can be used as a post-installation utility for the standard Red Hat Linux install.

After you complete the standard Red Hat install and restart the system, a Red Hat *first-boot* utility runs. After you specify a number of settings (such as the security level, time and date, root password, user accounts), the utility lets you to load additional disc.

The driver disc is used during this phase. All content added by HP is in the `/HP` directory on the disc. You can use it to build your own image or to browse the HP content.

 **NOTE:** Some installations may encounter problems if they are performed with a DisplayPort connection to the monitor. This is because the default drivers that the OS installers use do not support DisplayPort functionality. If you experience problems, try overriding the monitor choice for DisplayPort during the start of the install and using the VESA driver instead. You can then set up the DisplayPort monitor later.

Installing with the HP Red Hat Linux driver disc

1. If you do not have the appropriate HP driver disc for a supported stream, create one (see [HP Installer Kit for Linux \(HPIKL\) on page 43](#)).
2. Install the operating system using the optical media included in the Red Hat Linux box-set.
3. If you have a Red Hat driver disk for the OS version you are installing, enter `linux dd` on the initial install splash screen, and then press **Enter**.
4. When asked if you have a driver disc, select **Yes**. Place the Red Hat driver disc in the drive, and select the appropriate `drive:hd[abcd]`. Continue the normal installation.
5. After successfully installing the operating system, reboot the workstation.
 - RHEL 5: the Red Hat Setup Agent (also known as first-boot) automatically starts. At the **Additional DVDs** screen, insert your HP driver disc and select **Install**. When the driver installation task is completed, continue following the prompts until the operating system is successfully installed.
 - RHEL 6: Insert your HP driver disc. The HPIKL installation software automatically starts. Follow the prompts to install the contents.

Warranty

As part of the HP workstation hardware warranty, HP provides software configuration and installation support for certified versions of Red Hat Linux for up to 90 days from date of purchase.

Setting up SUSE Linux Enterprise Desktop (SLED)

HP offers a 64-bit SLED 11 preload on some Z series Workstations and supports 64-bit SLED 11 on other workstations.

Various versions of SLED are certified and supported by SUSE on HP workstations. For more information, refer to the SUSE certification bulletin search page at <http://developer.novell.com/yessearch>.

Setting up preloaded SLED

To set up SLED on systems preloaded with the operating system:

1. Start the workstation.
2. When prompted, enter the workstation installation settings: password, network, graphics, time, keyboard settings, and SUSE Customer Center Configuration.

 **NOTE:** You can activate your SUSE subscription from the SUSE Customer Center Configuration screen. To view the full SUSE Customer Center documentation, go to <http://www.suse.com/documentation> and select your operating system.

Installing SLED with the DVD Installer Kit

1. If an HP driver disc did not come with your workstation, create one (see [HP Installer Kit for Linux \(HPIKL\) on page 43](#)).
2. Install the operating system using the discs included in the SUSE box-set.
3. After successfully installing the operating system, reboot the workstation.
4. Insert your HP driver disc. The HPIKL installation software automatically starts. Follow the prompts to install the contents.

Warranty

HP provides configuration and installation support for SLED 11 on Z series Workstations for up to 90 days from date of purchase. SUSE also provides support for all versions of SLED that are certified on HP workstations.

Restoring SLED (preloaded systems only)

The SLED restore media is required to restore the Linux operating system. To create restore media:

1. Click the SUSE ISO icon on the desktop to go to the `/iso` folder. This folder contains all iso images used to preload your workstation.
2. Follow the instructions in the readme file in this folder to copy the ISO image file onto optical media.
3. Store the media in a safe place. If your workstation experiences a hard drive failure, use the ISO recovery images to restore your operating system.

 **CAUTION:** Restoring the operating system does **not** restore data. Back up your data using the method and media of your choice.

Proprietary graphics drivers

Most HP workstations can be ordered with graphics cards that have been through extensive verification by HP. See the *Hardware Support Matrix for HP Linux Workstations* at http://www.hp.com/support/linux_hardware_matrix for a list of supported cards.

 **NOTE:** Not all graphics cards are available on every workstation. Limitations generally occur for cards that consume large amounts of power in lower-power workstations.

Proprietary graphics drivers supported by HP and the graphics vendors are available with the HP Installer Kit for Linux, with the SLED 11 preload on Z series Workstations, and from HP Workstation Support at <http://www.hp.com/go/workstationsupport>.

These proprietary drivers are not a standard part of the RHEL or SLED distributions because they are not open source. Driver revisions more recent than those at the HP support website are supported directly by the vendor.

7 Updating the workstation

HP is constantly working on improving your total workstation experience. To ensure that the workstation leverages the latest enhancements, HP recommends that you install the latest BIOS, driver, and software updates on a regular basis.

Updating the workstation after first boot

After successfully booting the workstation for the first time, you should follow these guidelines to ensure that the workstation is up-to-date:

- Ensure that you have the latest system BIOS loaded. See [Upgrading the BIOS on page 47](#).
- Ensure that you have the latest drivers for your system. See [Upgrading device drivers on page 48](#).
- Become familiar with your available HP resources.
- Consider a subscription to Driver Alerts at <http://www.hp.com/go/subscriberschoice>.

Upgrading the BIOS

For optimum performance, determine the BIOS revision on the workstation, and upgrade it if necessary.

Determining the current BIOS version

To determine the current BIOS version:

1. Press **Esc** during power-up.
2. Press **F10** to enter the F10 Setup utility.
3. Select **File > System Information**. Note the workstation BIOS version and compare it with the BIOS versions that appear on the HP website.

 **NOTE:** For procedures for upgrading the BIOS as well as the F10 Setup utility BIOS Menu settings are located in the *Maintenance and Service Guide* at http://www.hp.com/support/workstation_manuals.

Upgrading BIOS

To find and download the latest available BIOS, which includes the latest enhancements:

1. Go to <http://www.hp.com/go/workstationsupport>.
2. Select **Download Drivers and Software** from the left menu column under Tasks.
3. Follow the instructions to locate the latest BIOS available for the workstation.
4. If the BIOS on the website is the same as the version on your system, no further action is required.
5. If the BIOS on the website is a version later than the one on your system, download the appropriate version for the workstation. Follow the instructions in the release notes to complete the installation.

Upgrading device drivers

If you install a peripheral device (such as a printer, display adapter, or network adapter), confirm you have the latest device drivers loaded. If you purchased your device through HP, visit the HP website to download the latest drivers for your device. These drivers have been tested to ensure the best compatibility between your device and your HP workstation.

If you did not purchase your device from HP, HP recommends visiting the HP website first to see if your device and its drivers have been tested for HP workstation compatibility. If no driver is available, visit the device manufacturer's website to download the latest drivers.

To upgrade device drivers:

1. Go to <http://www.hp.com/go/workstationsupport>.
2. Under **Tasks** in the left column, select **Download Drivers and Software**.
3. Follow the instructions to find the latest drivers available for the workstation.

If a needed driver is not found, see the website of the manufacturer of the peripheral device.

8 Diagnostics and Minor Troubleshooting

Calling support

At times you might encounter an issue that requires support. When you call support:

- Have the computer readily accessible.
- Write down the computer serial numbers, product numbers, model names, and model numbers and have them in front of you.
- Note any applicable error messages.
- Note any add-on options.
- Note the operating system.
- Note any third-party hardware or software.
- Note the details of any blinking LEDs on the front of the computer (tower and desktop configurations) or on the side of the computer (all-in-one configurations).
- Note the applications you were using when you encountered the problem.

 **NOTE:** When calling in for service or support, you might be asked for the product number (example: PS988AV) of the computer. If the computer has a product number, it is generally located next to the 10- or 12-digit serial number of the computer.

 **NOTE:** On most models, the serial number and product number labels can be found on the top or side panel and at the rear of the computer (tower and desktop configurations) or on a pull-out card on the side of the display (all-in-one configurations).

For a listing of all worldwide support phone numbers, go to <http://www.hp.com/support>, select your region, and click **Connect with HP** in the upper-right corner.

Locating ID labels

To assist in troubleshooting, product, serial, and authentication numbers are available on each computer.

- All workstations have a serial number (unique for each workstation) and product number. Have these numbers available when you contact support.
- The Certificate of Authentication (COA) is used for Windows 7-preinstalled systems only.
- The Genuine Microsoft Label (GML) is used for Windows 8-preinstalled systems only.
- A service label shows the build ID and Feature Byte strings, which are needed for system board replacement.

In general, these labels can be found in the top, rear, or bottom of the chassis (tower and desktop configuration) (your computer might look different).

Figure 8-1 Tower and desktop label locations



Locating warranty information

To locate base warranty information, see <http://www.hp.com/support/warranty-lookuptool>.

To locate an existing Care Pack, see <http://www.hp.com/go/lookuptool>.

To extend a standard product warranty, visit <http://www.hp.com/hps/carepack>. HP Care Pack Services offer upgraded service levels to extend and expand a standard product warranty.

HP troubleshooting resources and tools

This section provides information on HP Support Assistant (HPSA), online support, and helpful hints for troubleshooting.

HP Support Assistant (HPSA)

HPSA, which is available on select workstations running Windows 7, helps you maintain workstation performance and resolve problems. HPSA provides automated updates, onboard diagnostics, product information, and guided assistance to help maintain optimum workstation performance. To access HPSA, click **Start > All Programs > HP Help and Support > HP Support Assistant**.



NOTE: HP Support Assistant is not available on Linux or Windows 8.

Online support

Online access and support resources include web-based troubleshooting tools, technical knowledge databases, driver and patch downloads, online communities, and product change notification services.

The following websites are also available to you:

- <http://www.hp.com> — useful product information
- http://www.hp.com/support/workstation_manuals — the latest online documentation
- <http://www.hp.com/go/workstationsupport> — technical support information for workstations
- http://welcome.hp.com/country/us/en/wwcontact_us.html — worldwide support: chat with a technician, obtain email support, find support numbers, or locate an HP service center
- http://www.hp.com/support/workstation_swdrivers — software and drivers for workstations

Troubleshooting a problem

To help you troubleshoot problems with your system, HP provides the Business Support Center (BSC). The BSC is a portal to an extensive selection of online tools. To access BSC and troubleshoot a problem with the workstation, complete the following:

1. Visit <http://www.hp.com/go/workstationsupport>.
2. Under the **Business Support Center** menu on the left, select **Troubleshoot a problem**.
3. Under **Select your product** (center window), select **Workstations** (under **personal computing**).
4. Under **Select your product**, continue with selections as appropriate to the workstation series and model, and to the problem you are troubleshooting.

Instant Support and Active Chat

HPSA is a set of web-based support tools that automate and speed up the resolution of problems concerning desktop computing, tape storage, and printing.

Active Chat enables you to electronically submit a support ticket to HP over the Internet. When you submit a support ticket, Active Chat collects information about the computer and passes it to an online support specialist. The collection of information might take up to 30 seconds, depending on the computer configuration. When you submit a support ticket, you receive a confirmation message containing your case ID, the support hours for your location, and the estimated time of response.

For more information about HP Instant Support and Active Chat and how to use them, go to <http://instantsupport.hp.com/>.



NOTE: This feature is not available on Linux.

Customer Advisories, Customer and Security Bulletins, and Customer Notices

To find advisories, bulletins, and notices:

1. Visit <http://www.hp.com/go/workstationsupport>.
2. Select the desired product.
3. Under **Resources for <your selected product>**, select **See more...**
4. Under **Self-Help resources**: in the center of the window, choose the desired action and appropriate information in the scroll list to view the index.

Product Change Notifications

Product Change Notifications (PCNs) are proactive notifications for product changes occurring within a 30 to 60 day window of the manufacturing process change date. PCNs give customers advanced notice of changes to their product, such as an updated BIOS version. The latest PCNs are located at: <http://www.hp.com/go/workstationsupport>. Select your product, and then under **Resources for the HP Workstation**, click **See more**.

Helpful hints

If you encounter a problem with the workstation, monitor, or software, the following general suggestions might help you isolate and focus on the problem before taking further action.

At startup

- Verify that the workstation and monitor are plugged into a working electrical outlet.
- Remove all optical discs and USB drive keys from the drives before powering on the workstation.
- Verify that the workstation is turned on and the power light is on.
- If you have installed an operating system other than the factory-installed operating system, check to be sure that it is supported on your system by visiting <http://www.hp.com/go/quickspecs>.
- Verify that the monitor is turned on and the green monitor light is on.
- Turn up the brightness and contrast controls of the monitor if the monitor is dim.
- If the workstation has multiple video sources and only a single monitor, the monitor must be connected to the source selected as the primary VGA adapter. During startup, the other monitor connectors are disabled; if the monitor is connected to one of these ports, it will not function after Power-on Self Test (POST). You can select the default VGA source in Computer Setup (F10).

During operation

- Look for blinking LEDs on the workstation. The blinking lights are error codes that will help you diagnose the problem. Refer to the *Diagnostic lights and audible (beep) codes* section in the *Maintenance and Service Guide* for your workstation for information on interpreting diagnostic lights and audible codes.
- Press and hold any key. If the system beeps, your keyboard is operating correctly.
- Check all cables for loose or incorrect connections.
- Wake the workstation by pressing any key on the keyboard or the power button. If the system remains in suspend mode, shut down the system by pressing and holding the power button for at least four seconds, then press the power button again to restart the system. If the system does not shut down, unplug the power cord, wait a few seconds, then plug it in again. If it does not restart, press the power button to start the workstation.
- Reconfigure the workstation after installing a non–plug and play expansion board or other option. Refer to the *Hardware installation problems* section of this document for instructions.
- Be sure that all required device drivers have been installed. For example, if you have connected a printer, you must install a printer driver.
- If you are working on a network, plug another workstation with a different cable into the network connection. There might be a problem with the network plug or cable.
- If you recently added new hardware, remove the hardware and verify if the workstation functions properly.
- If you recently installed new software, uninstall the software and verify if the workstation functions properly.
- If the monitor connected to a tower, desktop or all-in-one computer is blank:

- Plug the monitor into a different video port on the computer if one is available. Alternatively, replace the monitor with a monitor that you know is working properly.
- Verify that the computer *and monitor* are plugged into a working electrical outlet.
- Verify that the monitor is turned on and the green monitor light is on.
- Turn up the brightness and contrast controls of the monitor if the monitor is dim.
- If the internal display on an all-in-one computer is blank, open the computer and make sure the graphics card is properly installed.
- Upgrade the BIOS. A new release of the BIOS might have been released that supports new features or fixes your problem.
- For more detailed information, see the troubleshooting chapter in the *Maintenance and Service Guide* at http://www.hp.com/support/workstation_manuals.

Customer self repair

Under the Customer self repair program, you can order a replacement part and install the part without onsite HP technical assistance. Customer self repair may be required for some components. See <http://www.hp.com/go/selfrepair> for information on the program.



NOTE: Some components are not eligible for customer self-repair and must be returned to HP for service. Call HP Support for further instructions before attempting to remove or repair these components.

Other troubleshooting options

The following additional troubleshooting techniques and tools are located in the *Maintenance and Service Guide* at http://www.hp.com/support/workstation_manuals:

- POST Error Codes
- Diagnostic LEDs and audible beep codes
- Troubleshooting scenarios and solutions
- HP Vision Diagnostics (Z420, Z620, Z820)
- HP PC Hardware Diagnostics (Z220 SFF and Z220 CMT)

9 Routine Care

General cleaning safety precautions

- Never use solvents or flammable solutions to clean the computer.
- Never immerse any component in water or cleaning solutions; apply any liquids to a clean cloth and then use the cloth on the component.
- Always unplug the computer before cleaning the keyboard, mouse, or air vents.
- Always disconnect the keyboard before cleaning it.
- Wear safety glasses equipped with side shields when cleaning the keyboard.

Cleaning the chassis

- Follow the safety precautions in the *Maintenance and Service Guide* for your workstation before cleaning the computer.
- To remove light stains or dirt, use plain water with a clean, lint-free cloth or swab.
- For stronger stains, use a mild dish washing liquid diluted with water. Rinse well by wiping it with a cloth or swab dampened with clear water.
- For stubborn stains, use isopropyl (rubbing) alcohol. No rinsing is required because the alcohol evaporates quickly and does not leave a residue.
- After cleaning, always wipe the computer with a clean, lint-free cloth.
- Occasionally, clean the air vents on the computer. Lint and other foreign matter can block the vents and limit the airflow.

Cleaning the keyboard

 **CAUTION:** Use safety glasses equipped with side shields before attempting to clean debris from under the keys.

- If the keyboard has an on/off switch, turn it off.
- Follow the safety precautions in the *Maintenance and Service Guide* for your workstation before cleaning the computer.
- Visible debris underneath or between the keys can be removed by vacuuming or shaking.
- Canned, pressurized air can be used to clean debris from under the keys. Use caution because too much air pressure can dislodge lubricants applied under the wide keys.
- If you remove a key, use a specially designed key remover to prevent damage to the keys. This tool is available from many electronic supply outlets.

 **CAUTION:** Never remove a wide key (like the space bar key) from the keyboard. If these keys are improperly removed or installed, the keyboard might not function properly.

- Clean under a key with a swab moistened with isopropyl alcohol and squeezed out. Be careful not to wipe away lubricants necessary for proper key functions. Allow the parts to air dry before reassembly.
- Use tweezers to remove any fibers or dirt in confined areas.

Cleaning the monitor

- Follow the safety precautions in the *Maintenance and Service Guide* for your workstation before cleaning the computer.
- To clean the monitor, wipe the monitor screen with a towelette designed for cleaning monitors or a clean cloth moistened with water.

 **CAUTION:** Do not use sprays or aerosols directly on the screen—the liquid might seep into the housing and damage a component.

Never use solvents or flammable liquids on the monitor because display or housing damage may result.

Cleaning the mouse

1. Follow the safety precautions in the *Maintenance and Service Guide* for your workstation before cleaning the computer.
2. If the mouse has an on/off switch, turn it off.
3. Wipe the body of the mouse with a damp cloth.
4. If the mouse has a:
 - Laser or LED: use a cotton swab dampened with cleaning solution to gently brush out any dust around the laser or LED, then wipe again with a dry swab. Do not wipe the laser or LED directly with the swab.
 - Scroll wheel: spray canned, pressurized air in the gap between the scroll wheel and the click buttons. Do not blow air directly on one spot for very long or condensation can form.
 - Roller ball: remove and clean the roller ball, remove any debris from the ball socket, wipe out the socket with a dry cloth, and reassemble the mouse.