



Hardware Reference Guide

HP ProDesk 400 G4 SFF Business PC



View our **400 G4**
inventory here

© Copyright 2017 HP Development Company, L.P.

Windows is either a registered trademark or trademark of Microsoft Corporation in the United States and/or other countries.

The information contained herein is subject to change without notice. The only warranties for HP products and services are set forth in the express warranty statements accompanying such products and services. Nothing herein should be construed as constituting an additional warranty. HP shall not be liable for technical or editorial errors or omissions contained herein.

First Edition: January 2017

Document Part Number: 913314-001

Product notice

This user guide describes features that are common to most models. Some features may not be available on your computer.

Not all features are available in all editions or versions of Windows. Systems may require upgraded and/or separately purchased hardware, drivers, software or BIOS update to take full advantage of Windows functionality. Windows 10 is automatically updated, which is always enabled. ISP fees may apply and additional requirements may apply over time for updates. See <http://www.microsoft.com>.

To access the latest user guides or manuals for your product, go to <http://www.hp.com/support>. Select **Find your product**, and then follow the on-screen instructions.

Software terms

By installing, copying, downloading, or otherwise using any software product preinstalled on this computer, you agree to be bound by the terms of the HP End User License Agreement (EULA). If you do not accept these license terms, your sole remedy is to return the entire unused product (hardware and software) within 14 days for a full refund subject to the refund policy of your seller.

For any further information or to request a full refund of the price of the computer, please contact your seller.

Safety warning notice

 **WARNING!** To reduce the possibility of heat-related injuries or of overheating the computer, do not place the computer directly on your lap or obstruct the computer air vents. Use the computer only on a hard, flat surface. Do not allow another hard surface, such as an adjoining optional printer, or a soft surface, such as pillows or rugs or clothing, to block airflow. Also, do not allow the AC adapter to come into contact with the skin or a soft surface, such as pillows or rugs or clothing, during operation. The computer and the AC adapter comply with the user-accessible surface temperature limits defined by the International Standard for Safety of Information Technology Equipment (IEC 60950-1).

About This Book

This guide provides basic information for upgrading the HP ProDesk Business PC.

 **WARNING!** Text set off in this manner indicates that failure to follow directions could result in bodily harm or loss of life.

 **CAUTION:** Text set off in this manner indicates that failure to follow directions could result in damage to equipment or loss of information.

 **NOTE:** Text set off in this manner provides important supplemental information.

Table of contents

1 Product features	1
Standard configuration features	1
Front panel components	2
Rear panel components	3
Serial number location	3
2 Hardware upgrades	4
Serviceability features	4
Warnings and cautions	4
Removing the computer access panel	5
Replacing the computer access panel	6
Removing the front bezel	7
Removing a slim optical drive bezel blank	8
Replacing the front bezel	8
Changing from desktop to tower configuration	9
System board connectors	10
Installing additional memory	11
DIMMs	11
DDR4-SDRAM DIMMs	11
Populating DIMM sockets	11
Installing DIMMs	12
Removing or installing an expansion card	18
Drive positions	21
Removing and installing drives	22
Removing a 9.5 mm slim optical drive	23
Installing a 9.5 mm slim optical drive	24
Removing and replacing a hard drive	26
Installing a security lock	32
Security cable lock	32
Padlock	32
HP Business PC Security Lock V2	33
Appendix A Battery replacement	38
Appendix B Electrostatic discharge	41
Preventing electrostatic damage	41

Grounding methods	41
Appendix C Computer operating guidelines, routine care and shipping preparation	42
Computer operating guidelines and routine care	42
Optical drive precautions	43
Operation	43
Cleaning	43
Safety	43
Shipping preparation	43
Appendix D Accessibility	44
Supported assistive technologies	44
Contacting support	44
Index	45

1 Product features

Standard configuration features

Features may vary depending on the model. For support assistance and to learn more about the hardware and software installed on your computer model, run the HP Support Assistant utility.

 **NOTE:** This computer model can be used in a tower orientation or a desktop orientation.



Front panel components

Drive configuration may vary by model. Some models have a bezel blank covering the slim optical drive bay.

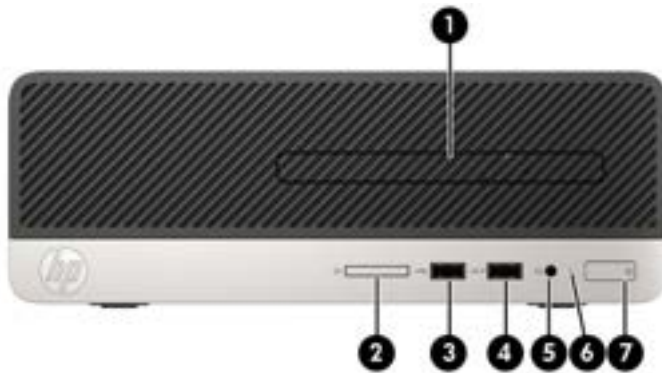







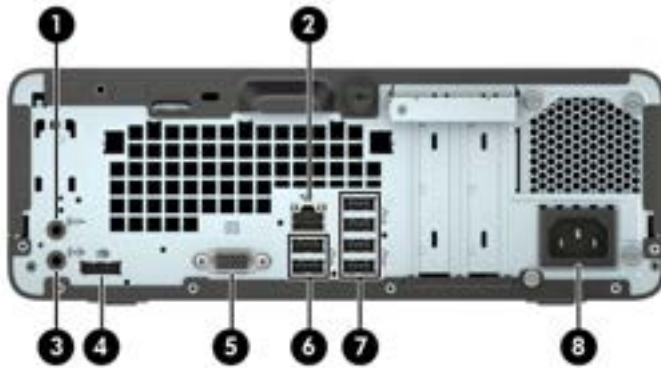

1	Slim optical drive (optional)	5	Audio-out (headphone)/Audio-in (microphone) combo jack
2	Memory card reader	6	Hard drive activity light
3	USB 2.0 port	7	Dual-state power button
4	USB 2.0 port with HP Sleep and Charge*		

*This port connects a USB device, provides high-speed data transfer, and even when the computer is off, charges products such as a cell phone, camera, activity tracker, or smartwatch.

NOTE: When a device is plugged into the combo jack, a dialog box will open asking if you want to use the connector for a microphone line-in device or a headphone. You can reconfigure the connector at any time by double-clicking the Audio Manager icon in the Windows® taskbar.

Rear panel components



1	 Audio-in jack	5	 VGA monitor connector
2	 RJ-45 (network) jack	6	 USB 2.0 ports (2)
3	 Audio-out jack for powered audio devices	7	 USB 3.x ports (4)
4	 DisplayPort monitor connector	8	Power cord connector

NOTE: When a device is plugged into the audio-in jack, a dialog box will open asking if you want to use the connector for a microphone line-in device or a headphone. You can reconfigure the connector at any time by double-clicking the Audio Manager icon in the Windows® taskbar.

When a graphics card is installed in one of the system board slots, the video connectors on the graphics card and the integrated graphics on the system board may be used at the same time. However, for such a configuration, only the display connected to the discrete graphics card will display POST messages.

The system board graphics can be disabled by changing settings in Computer Setup.

Serial number location

Each computer has a unique serial number and a product ID number that are located on the exterior of the computer. Keep these numbers available for use when contacting support for assistance.



2 Hardware upgrades

Serviceability features

The computer includes features that make it easy to upgrade and service. No tools are needed for most of the installation procedures described in this chapter. A T15 Torx or flat-bladed screwdriver is needed for some of the installation procedures.

Warnings and cautions

Before performing upgrades be sure to carefully read all of the applicable instructions, cautions, and warnings in this guide.

 **WARNING!** To reduce the risk of personal injury from electrical shock, hot surfaces, or fire:

Disconnect the power cord from the AC outlet and allow the internal system components to cool before you touch them.

Do not plug telecommunications or telephone connectors into the network interface controller (NIC) receptacles.

Do not disable the power cord grounding plug. The grounding plug is an important safety feature.

Plug the power cord into a grounded (earthed) outlet that is easily accessible at all times.

To reduce the risk of serious injury, read the *Safety & Comfort Guide*. It describes proper workstation setup, and proper posture, health, and work habits for computer users. The *Safety & Comfort Guide* also provides important electrical and mechanical safety information. The *Safety & Comfort Guide* is available on the Web at <http://www.hp.com/ergo>.

 **WARNING!** Energized and moving parts inside.

Disconnect power to the equipment before removing the enclosure.

Replace and secure the enclosure before re-energizing the equipment.

 **CAUTION:** Static electricity can damage the electrical components of the computer or optional equipment. Before beginning these procedures, ensure that you are discharged of static electricity by briefly touching a grounded metal object. See [Electrostatic discharge on page 41](#) for more information.

When the computer is plugged into an AC power source, voltage is always applied to the system board. You must disconnect the power cord from the power source before opening the computer to prevent damage to internal components.

Removing the computer access panel

To access internal components, you must remove the access panel:

1. Remove/disengage any security devices that prohibit opening the computer.
2. Remove all removable media, such as compact discs or USB flash drives, from the computer.
3. Turn off the computer properly through the operating system, then turn off any external devices.
4. Disconnect the power cord from the power outlet and disconnect any external devices.

⚠ CAUTION: Regardless of the power-on state, voltage is always present on the system board as long as the system is plugged into an active AC outlet. You must disconnect the power cord to avoid damage to the internal components of the computer.

5. Loosen the thumbscrew on the rear of the computer (1), slide the panel back (2), and lift it off the computer (3).



Replacing the computer access panel

Place the panel on the computer (1), slide it forward (2), and tighten the thumbscrew (3) to secure the panel in place.



Removing the front bezel

1. Remove/disengage any security devices that prohibit opening the computer.
2. Remove all removable media, such as compact discs or USB flash drives, from the computer.
3. Turn off the computer properly through the operating system, then turn off any external devices.
4. Disconnect the power cord from the power outlet and disconnect any external devices.

⚠ CAUTION: Regardless of the power-on state, voltage is always present on the system board as long as the system is plugged into an active AC outlet. You must disconnect the power cord to avoid damage to the internal components of the computer.

5. Remove the computer access panel. See [Removing the computer access panel on page 5](#).
6. Lift up the four tabs on the top side of the bezel (1), and then rotate the bezel off the chassis (2).

📝 NOTE: You may need a tool to pry up the three bezel tabs, or you can remove the hard drive cage to make the tabs easier to access.

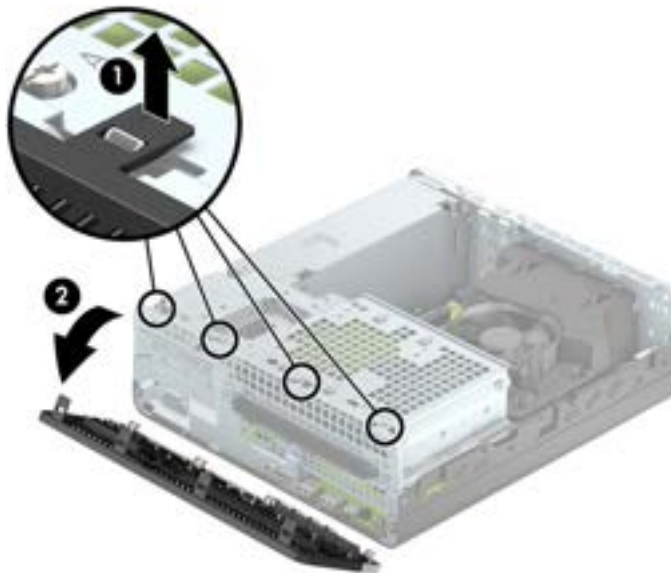

Removing a slim optical drive bezel blank

On some models, there is a bezel blank covering the slim optical drive bay that needs to be removed before installing an optical drive. To remove the bezel blank:

1. Remove the computer access panel and front bezel. See [Removing the computer access panel on page 5](#) and [Removing the front bezel on page 7](#).
2. To remove a slim optical drive bezel blank, press inward on the two retaining tabs (1) and pull the blank off the front bezel (2).

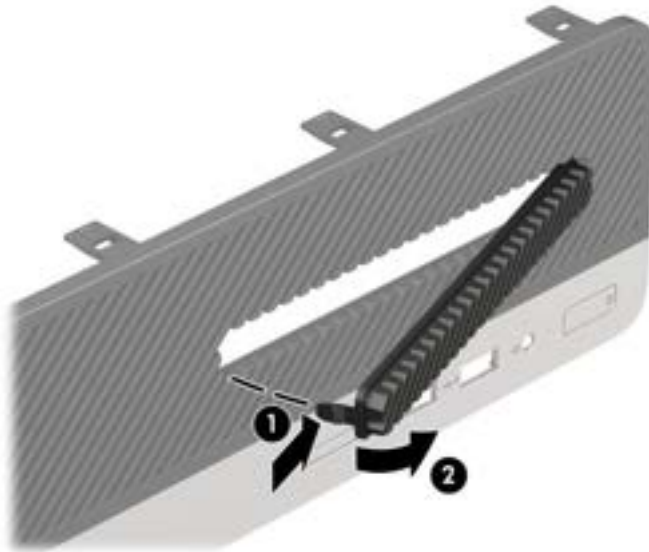

Replacing the front bezel

Insert the three hooks on the bottom side of the bezel into the rectangular holes on the chassis (1), and then rotate the top side of the bezel onto the chassis (2) and snap it into place.

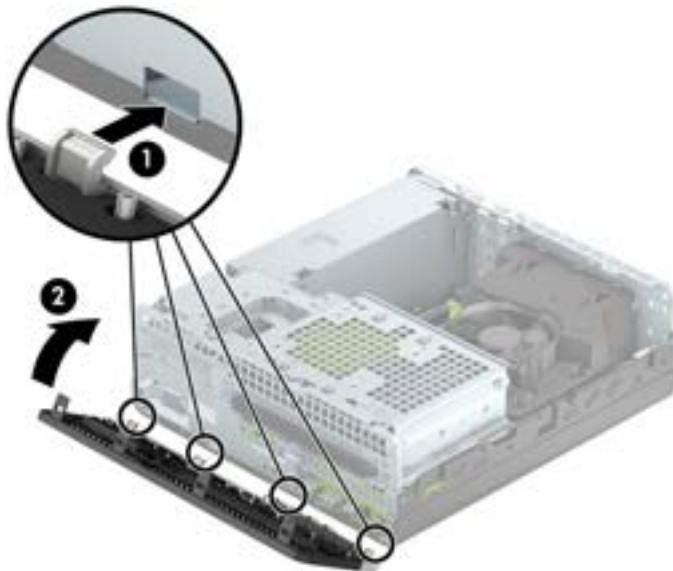

Changing from desktop to tower configuration

The Small Form Factor computer can be used in a tower orientation with an optional tower stand that can be purchased from HP.

1. Remove/disengage any security devices that prohibit opening the computer.
2. Remove all removable media, such as compact discs or USB flash drives, from the computer.
3. Turn off the computer properly through the operating system, then turn off any external devices.
4. Disconnect the power cord from the power outlet and disconnect any external devices.

⚠ CAUTION: Regardless of the power-on state, voltage is always present on the system board as long as the system is plugged into an active AC outlet. You must disconnect the power cord to avoid damage to the internal components of the computer.

5. Orient the computer so that its right side is facing down and place the computer in the optional stand.



📝 NOTE: To stabilize the computer in a tower orientation, HP recommends the use of the optional tower stand.

6. Reconnect the power cord and any external devices, then turn on the computer.

📝 NOTE: Ensure at least 10.2 centimeters (4 inches) of space on all sides of the computer remains clear and free of obstructions.

7. Lock any security devices that were disengaged when the access panel was removed.

System board connectors

Refer to the following illustration and table to identify the system board connectors for your model.

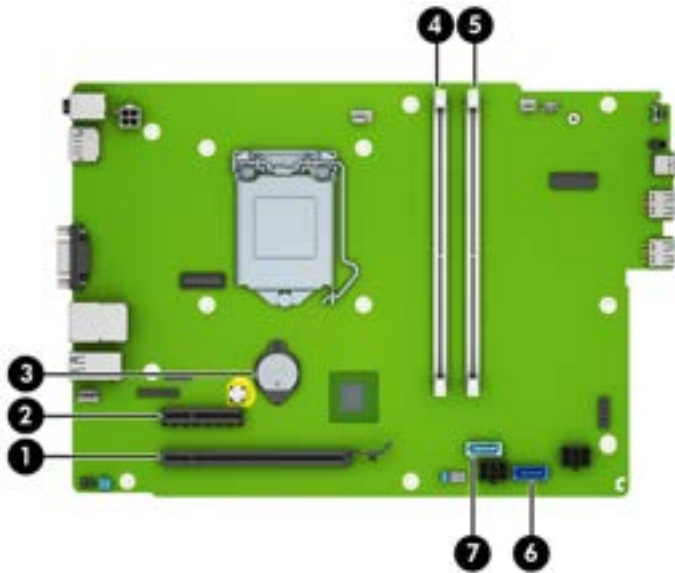

No.	System Board Connector	System Board Label	Color	Component
1	PCI Express x16	X16PCIEXP	Black	Expansion Card
2	PCI Express x4	X4PCIEXP	Black	Expansion Card
3	Battery	BAT	Black	Memory Module
4	DIMM2	DIMM2	White	Memory Module
5	DIMM1	DIMM1	White	Memory Module
6	SATA 3.0	SATA0	Dark blue	Primary Hard Drive
7	SATA 3.0	SATA1	Light blue	Optical Drive

Installing additional memory

The computer comes with double data rate 4 synchronous dynamic random access memory (DDR4-SDRAM) dual inline memory modules (DIMMs).

DIMMs

The memory sockets on the system board can be populated with up to two industry-standard DIMMs. These memory sockets are populated with at least one preinstalled DIMM. To achieve the maximum memory support, you can populate the system board with up to 32-GB of memory configured in a high-performing dual channel mode.

DDR4-SDRAM DIMMs

For proper system operation, the DIMMs must be:

- Industry-standard 288-pin
- Unbuffered non-ECC PC4-17000 DDR4-2133 MHz-compliant
- 1.2 volt DDR4-SDRAM DIMMs

The DIMMs must also:

- Support CAS latency 15 DDR4 2133 MHz (15-15-15 timing)
- Contain the mandatory JEDEC SPD information

In addition, the computer supports:

- 512-MB, 1GB, and 2-GB non-ECC memory technologies
- Single-sided and double-sided DIMMs
- DIMMs constructed with x8 and x16 DDR devices; DIMMs constructed with x4 SDRAM are not supported



NOTE: The system will not operate properly if you install unsupported DIMMs.

Populating DIMM sockets

There are two DIMM sockets on the system board, with one socket per channel. The sockets are labeled DIMM1 and DIMM3. Socket DIMM1 operates in memory channel B. Socket DIMM3 operates in memory channel A.

The system will automatically operate in single channel mode, dual channel mode, or flex mode, depending on how the DIMMs are installed.



NOTE: Single channel and unbalanced dual channel memory configurations will result in inferior graphics performance.

- The system will operate in single channel mode if the DIMM sockets are populated in one channel only.
- The system will operate in a higher-performing dual channel mode if the memory capacity of the DIMM in Channel A is equal to the memory capacity of the DIMM in Channel B.
- The system will operate in flex mode if the memory capacity of the DIMM in Channel A is not equal to the memory capacity of the DIMM in Channel B. In flex mode, the channel populated with the least amount of memory describes the total amount of memory assigned to dual channel and the remainder is

assigned to single channel. If one channel will have more memory than the other, the larger amount should be assigned to Channel A.

- In any mode, the maximum operational speed is determined by the slowest DIMM in the system.

Installing DIMMs

⚠ CAUTION: You must disconnect the power cord and wait approximately 30 seconds for the power to drain before adding or removing memory modules. Regardless of the power-on state, voltage is always supplied to the memory modules as long as the computer is plugged into an active AC outlet. Adding or removing memory modules while voltage is present may cause irreparable damage to the memory modules or system board.

The memory module sockets have gold-plated metal contacts. When upgrading the memory, it is important to use memory modules with gold-plated metal contacts to prevent corrosion and/or oxidation resulting from having incompatible metals in contact with each other.

Static electricity can damage the electronic components of the computer or optional cards. Before beginning these procedures, ensure that you are discharged of static electricity by briefly touching a grounded metal object. For more information, refer to [Electrostatic discharge on page 41](#).

When handling a memory module, be careful not to touch any of the contacts. Doing so may damage the module.

-
1. Remove/disengage any security devices that prohibit opening the computer.
 2. Remove all removable media, such as compact discs or USB flash drives, from the computer.
 3. Turn off the computer properly through the operating system, then turn off any external devices.
 4. Disconnect the power cord from the power outlet and disconnect any external devices.

⚠ CAUTION: You must disconnect the power cord and wait approximately 30 seconds for the power to drain before adding or removing memory modules. Regardless of the power-on state, voltage is always supplied to the memory modules as long as the computer is plugged into an active AC outlet. Adding or removing memory modules while voltage is present may cause irreparable damage to the memory modules or system board.

-
5. Remove the computer access panel. See [Removing the computer access panel on page 5](#).

⚠ WARNING! To reduce risk of personal injury from hot surfaces, allow the internal system components to cool before touching.

6. Disconnect the power cable (1) and data cable (2) from the rear of the optical drive.



7. Press the release lever on the back of the drive (1), and then slide the drive through the front bezel (2).

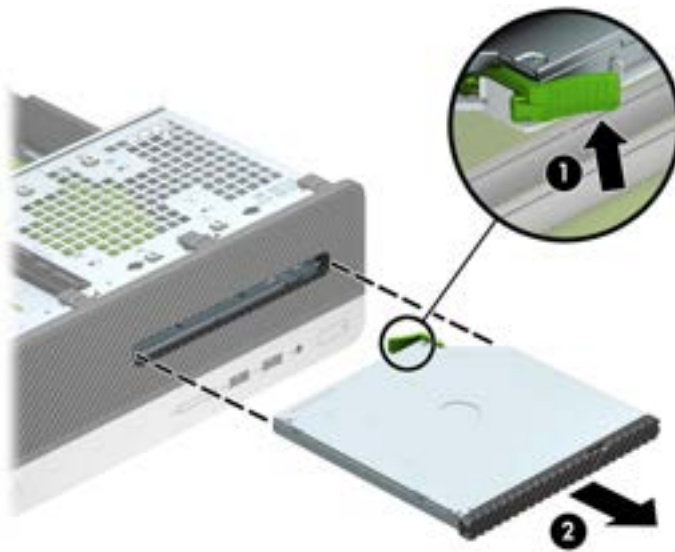

8. Disconnect the data cable (1) and power cable (2) from the rear of the hard drive.

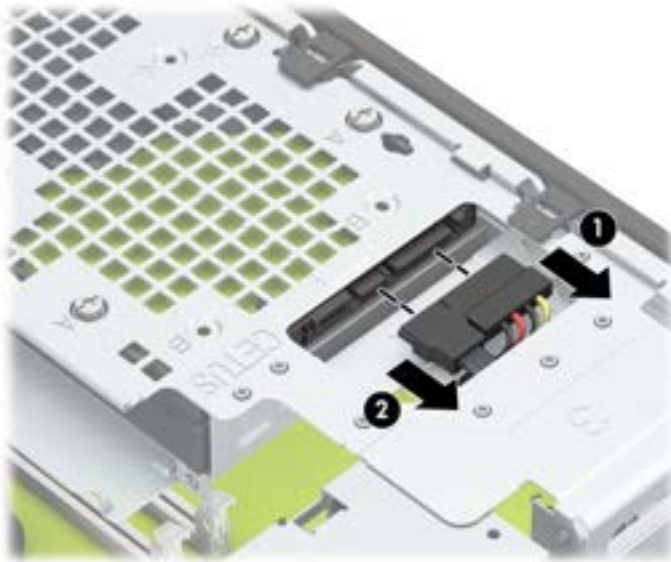

9. Press inward on the drive cage release latch (1), rotate the drive cage up (2), and then slide the tabs on the side of the drive cage out of the chassis (3).

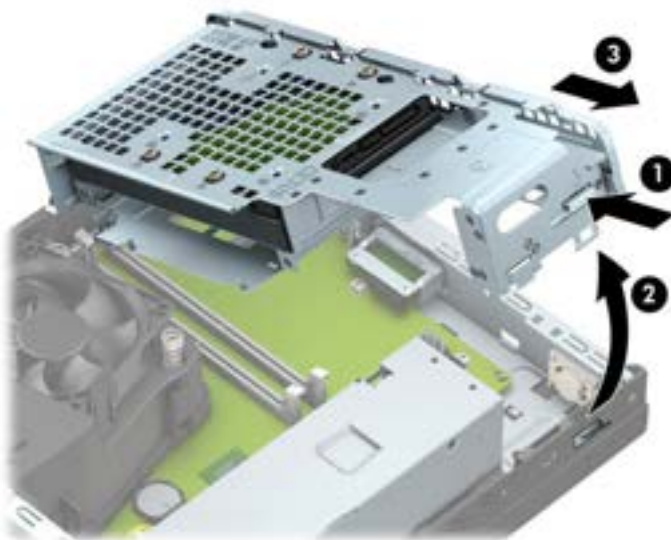

10. Open both latches of the memory module socket (1), and insert the memory module into the socket (2). Push the module down into the socket, ensuring that the module is fully inserted and properly seated. Make sure the latches are in the closed position (3).

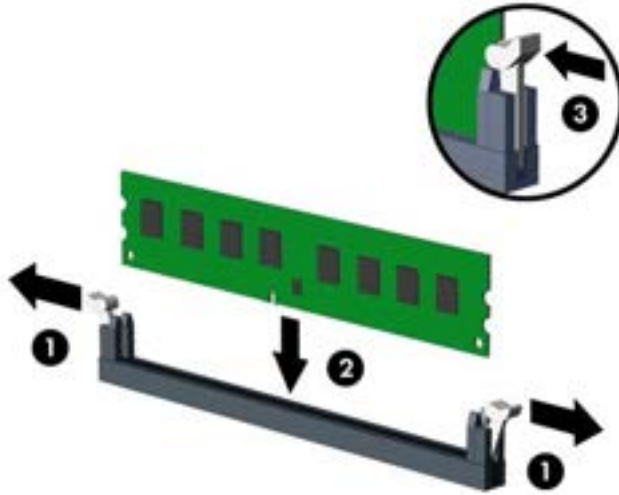

 **NOTE:** A memory module can be installed in only one way. Match the notch on the module with the tab on the memory socket.

For maximum performance, populate the sockets so that the memory capacity is spread as equally as possible between Channel A and Channel B. Refer to [Populating DIMM sockets on page 11](#) for more information.

11. Hold the drive cage at an angle and insert the tabs on the side of the drive cage into the slots on the chassis (1), and then lower the other side of the drive cage down so that the latch snaps onto the chassis (2).

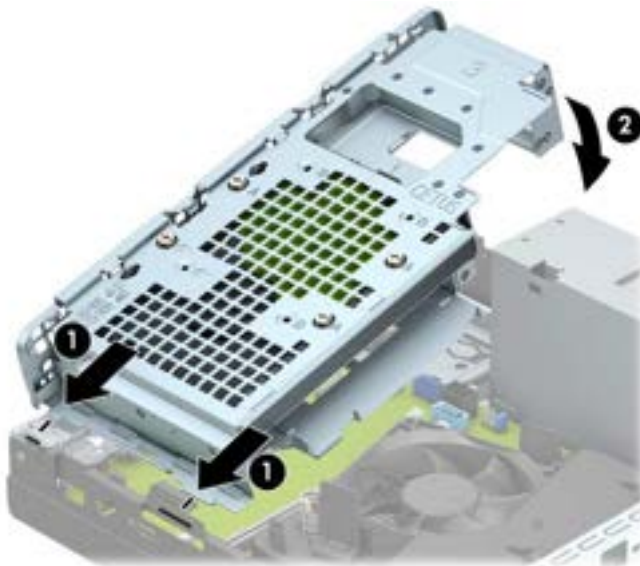

12. Connect the power cable (1) and data cable (2) to the rear of the hard drive.

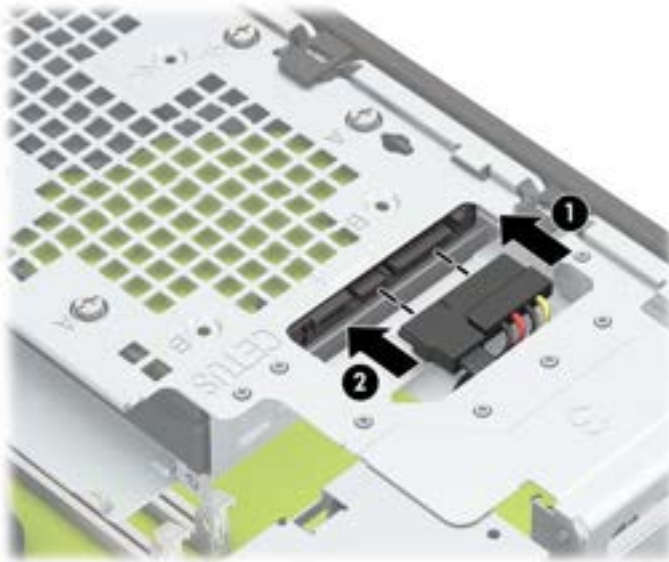

13. Slide the optical drive through the front bezel all the way into the bay (1) so that it locks in place (2).

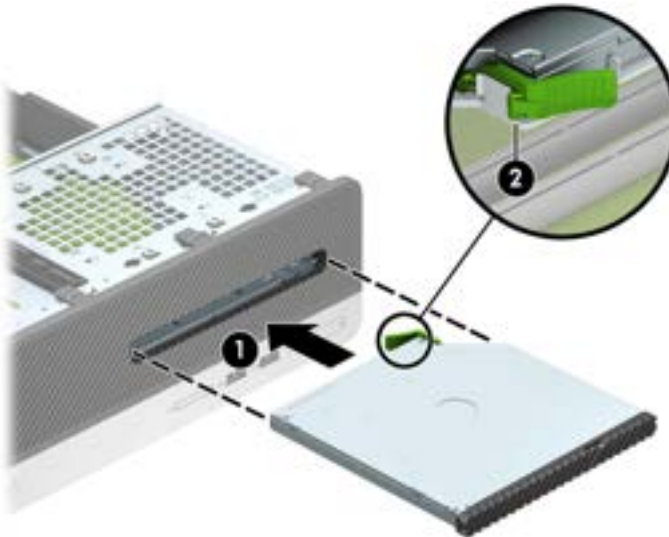

14. Connect the power cable (1) and data cable (2) to the rear of the drive.



15. Replace the access panel.
16. Reconnect the power cord and any external devices, then turn on the computer. The computer should automatically recognize the additional memory.
17. Lock any security devices that were disengaged when the access panel was removed.

Removing or installing an expansion card

The computer has one PCI Express x1 expansion socket and one PCI Express x16 expansion socket.

 **NOTE:** The PCI Express sockets support only low profile cards.

You can install a PCI Express x1, x4, x8, or x16 expansion card in the PCI Express x16 socket.

For dual graphics card configurations, the first (primary) card must be installed in the PCI Express x16 socket.

To remove, replace, or add an expansion card:

1. Remove/disengage any security devices that prohibit opening the computer.
2. Remove all removable media, such as compact discs or USB flash drives, from the computer.
3. Turn off the computer properly through the operating system, then turn off any external devices.
4. Disconnect the power cord from the power outlet and disconnect any external devices.

 **CAUTION:** Regardless of the power-on state, voltage is always present on the system board as long as the system is plugged into an active AC outlet. You must disconnect the power cord to avoid damage to the internal components of the computer.

5. Remove the computer access panel. See [Removing the computer access panel on page 5](#).
6. Locate the correct vacant expansion socket on the system board and the corresponding expansion slot cover on the back of the computer chassis.
7. Rotate the slot cover release latch to the open position.



8. Before installing an expansion card, remove the expansion slot cover or the existing expansion card.

 **NOTE:** Before removing an installed expansion card, disconnect any cables that may be attached to the expansion card.

- a. If you are installing an expansion card in a vacant PCI Express x1 socket, insert a flat-bladed screwdriver into the slots on the rear of expansion slot cover (1) and rock the slot cover back and forth to break it free from the chassis (2).

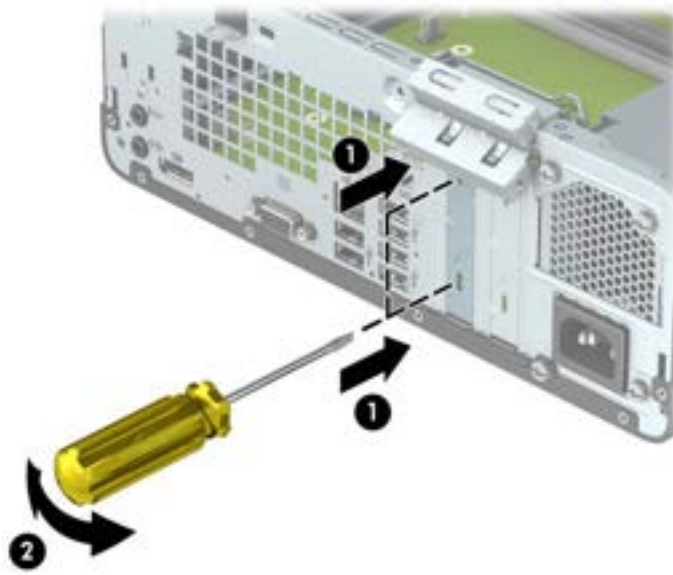

- b.** If you are removing a PCI Express x1 card, hold the card at each end, and carefully rock it back and forth until the connectors pull free from the socket. Pull the expansion card straight up from the socket (1), then remove the card from the expansion slot cover tray (2).

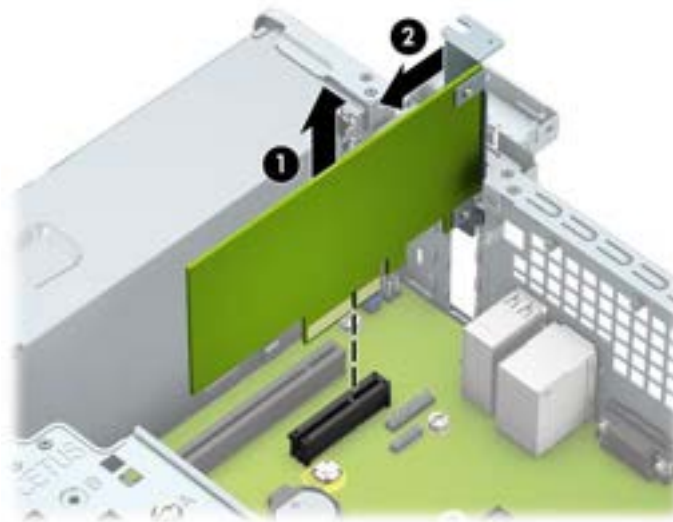

- c. If you are removing a PCI Express x16 card, pull the retention arm on the back of the expansion socket away from the card and carefully rock the card back and forth until the connectors pull free from the socket. Pull the expansion card straight up from the socket.

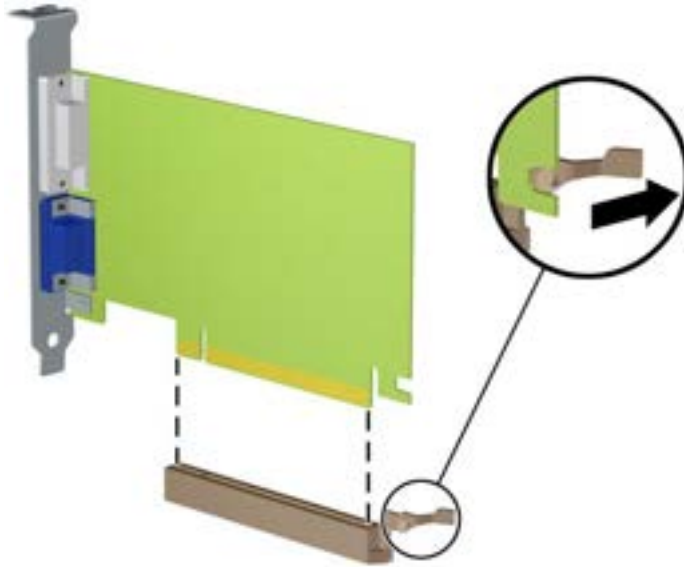

9. Store the removed card in anti-static packaging.
10. If you are not installing a new expansion card, install an expansion slot cover to close the open slot.

CAUTION: After removing an expansion card, you must replace it with a new card or expansion slot cover for proper cooling of internal components during operation.

11. To install a new expansion card, hold the card just above the expansion socket on the system board and then move the card toward the rear of the chassis (1) so that the bracket on the card is aligned with the open slot on the rear of the chassis. Press the card straight down into the expansion socket on the system board (2).

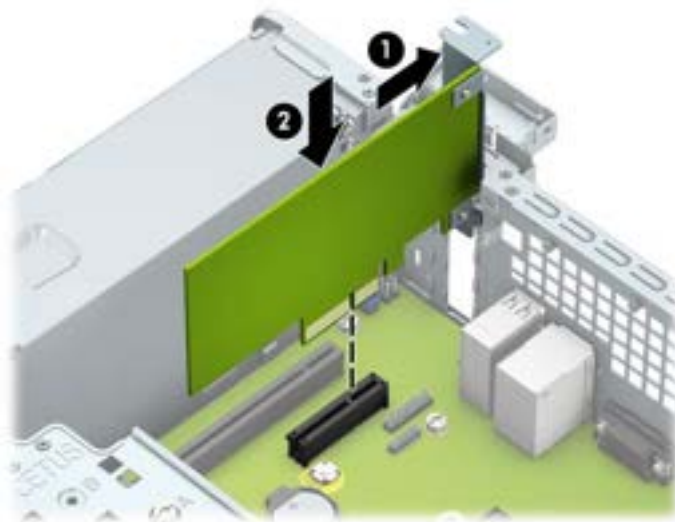

NOTE: When installing an expansion card, press firmly on the card so that the whole connector seats properly in the expansion card socket.

12. Rotate the slot cover retention latch back in place to secure the expansion card.

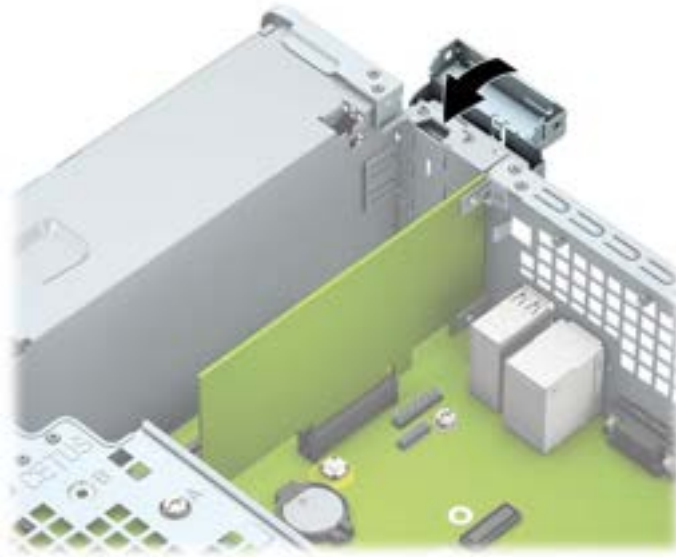

13. Connect external cables to the installed card, if needed. Connect internal cables to the system board, if needed.
14. Replace the computer access panel.
15. Reconnect the power cord and any external devices, then turn on the computer.
16. Lock any security devices that were disengaged when the access panel was removed.
17. Reconfigure the computer, if necessary.

Drive positions

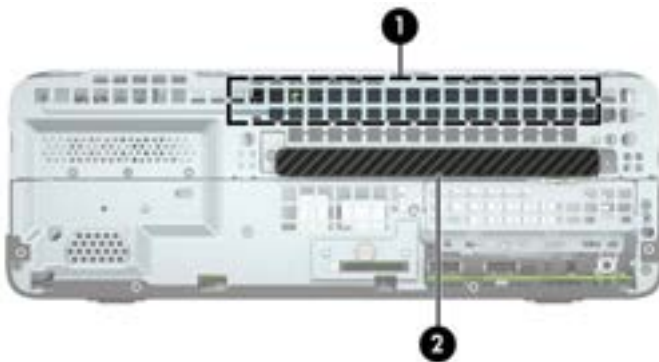

-
- | | |
|---|-------------------------------|
| 1 | Hard drive bay |
| 2 | 9.5 mm slim optical drive bay |
-

NOTE: The drive configuration on your computer may be different than the drive configuration shown above.

To verify the type and size of the storage devices installed in the computer, run Computer Setup.

Removing and installing drives

When installing drives, follow these guidelines:

- The primary Serial ATA (SATA) hard drive must be connected to the dark blue primary SATA connector on the system board labeled SATA0.
- Connect an optical drive to the light blue SATA connector on the system board labeled SATA1.

 **CAUTION:** To prevent loss of work and damage to the computer or drive:

If you are inserting or removing a drive, shut down the operating system properly, turn off the computer, and unplug the power cord. Do not remove a drive while the computer is on or in standby mode.

Before handling a drive, ensure that you are discharged of static electricity. While handling a drive, avoid touching the connector. For more information about preventing electrostatic damage, refer to [Electrostatic discharge on page 41](#).

Handle a drive carefully; do not drop it.

Do not use excessive force when inserting a drive.

Avoid exposing a hard drive to liquids, temperature extremes, or products that have magnetic fields such as monitors or speakers.

If a drive must be mailed, place the drive in a bubble-pack mailer or other protective packaging and label the package “Fragile: Handle With Care.”

Removing a 9.5 mm slim optical drive

⚠ CAUTION: All removable media should be taken out of a drive before removing the drive from the computer.

1. Remove/disengage any security devices that prohibit opening the computer.
2. Remove all removable media, such as compact discs or USB flash drives, from the computer.
3. Turn off the computer properly through the operating system, then turn off any external devices.
4. Disconnect the power cord from the power outlet and disconnect any external devices.

⚠ CAUTION: Regardless of the power-on state, voltage is always present on the system board as long as the system is plugged into an active AC outlet. You must disconnect the power cord to avoid damage to the internal components of the computer.

5. Remove the computer access panel. See [Removing the computer access panel on page 5](#).
6. Disconnect the power cable (1) and data cable (2) from the rear of the optical drive.



7. Press the release lever on the back of the drive (1), and then slide the drive through the front bezel (2).

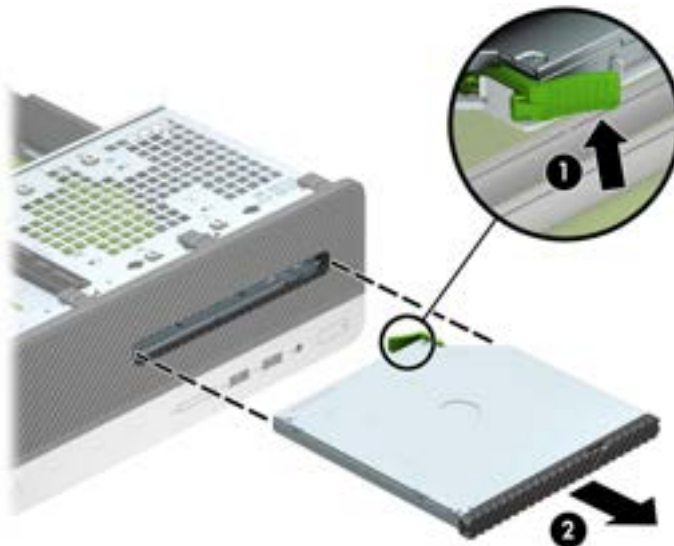

Installing a 9.5 mm slim optical drive

1. Remove/disengage any security devices that prohibit opening the computer.
2. Remove all removable media, such as compact discs or USB flash drives, from the computer.
3. Turn off the computer properly through the operating system, then turn off any external devices.
4. Disconnect the power cord from the power outlet and disconnect any external devices.

⚠ CAUTION: Regardless of the power-on state, voltage is always present on the system board as long as the system is plugged into an active AC outlet. You must disconnect the power cord to avoid damage to the internal components of the computer.

5. Remove the computer access panel. See [Removing the computer access panel on page 5](#).
6. Remove the front bezel if you are installing a drive in a bay covered by a bezel blank, and then remove the bezel blank. See [Removing a slim optical drive bezel blank on page 8](#) for more information.
7. Align the small pin on the release latch with the small hole on the side of the drive and press the latch firmly onto the drive.



- Slide the optical drive through the front bezel all the way into the bay (1) so that it locks in place (2).

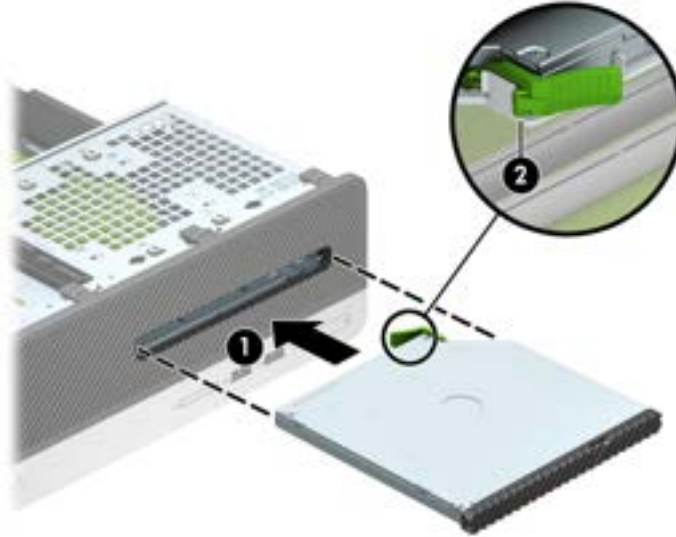

- Connect the power cable (1) and data cable (2) to the rear of the drive.



- Connect the opposite end of the data cable to the light blue SATA connector on the system board labeled SATA1.



NOTE: Refer to [System board connectors on page 10](#) for an illustration of the system board drive connectors.

- Replace the front bezel if it was removed.
- Replace the computer access panel.
- Reconnect the power cord and any external devices, then turn on the computer.
- Lock any security devices that were disengaged when the access panel was removed.

Removing and replacing a hard drive

 **NOTE:** Before you remove the old hard drive, be sure to back up the data from the old hard drive so that you can transfer the data to the new hard drive.

1. Remove/disengage any security devices that prohibit opening the computer.
2. Remove all removable media, such as compact discs or USB flash drives, from the computer.
3. Turn off the computer properly through the operating system, then turn off any external devices.
4. Disconnect the power cord from the power outlet and disconnect any external devices.

 **CAUTION:** Regardless of the power-on state, voltage is always present on the system board as long as the system is plugged into an active AC outlet. You must disconnect the power cord to avoid damage to the internal components of the computer.

5. Remove the computer access panel. See [Removing the computer access panel on page 5](#).
6. Disconnect the power cable (1) and data cable (2) from the rear of the optical drive.



7. Press the release lever on the back of the drive (1), and then slide the drive through the front bezel (2).

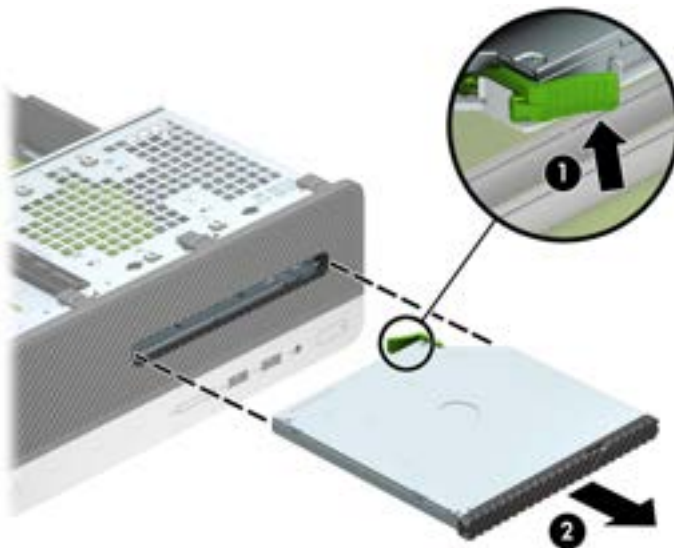

8. Disconnect the data cable (1) and power cable (2) from the rear of the hard drive.

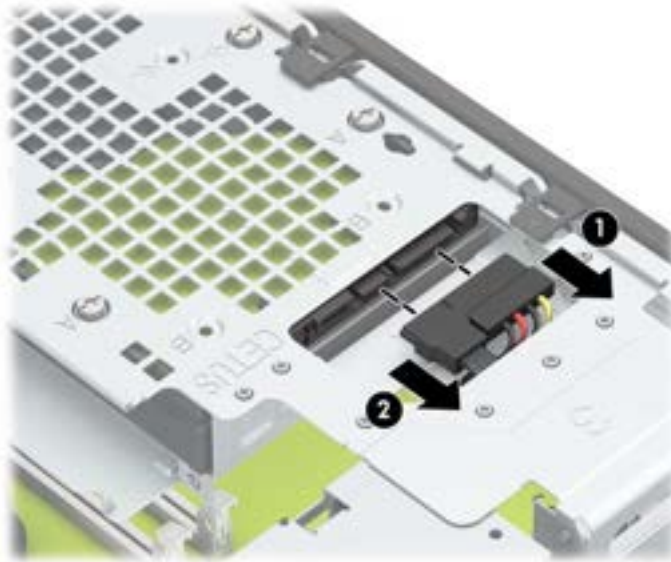

9. Press inward on the drive cage release latch (1), rotate the drive cage up (2), and then slide the tabs on the side of the drive cage out of the chassis (3).

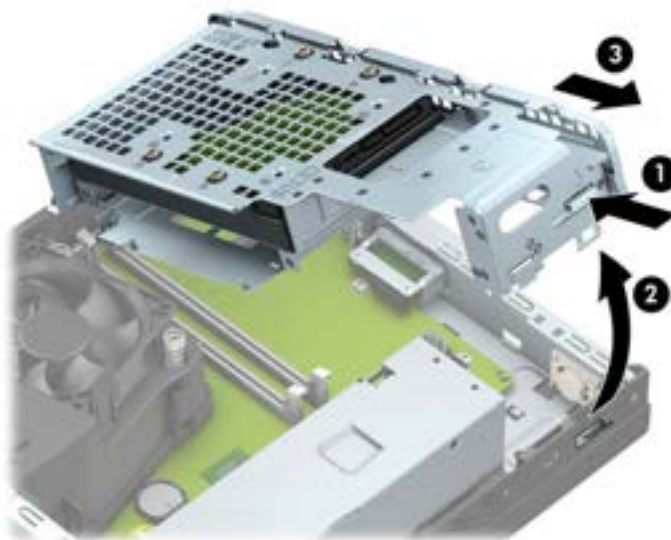

10. Remove the hard drive from the drive cage.
- If you are removing a 3.5-inch hard drive, remove the four screws that secure the drive to the drive cage (1), and then slide the drive out of the cage (2).

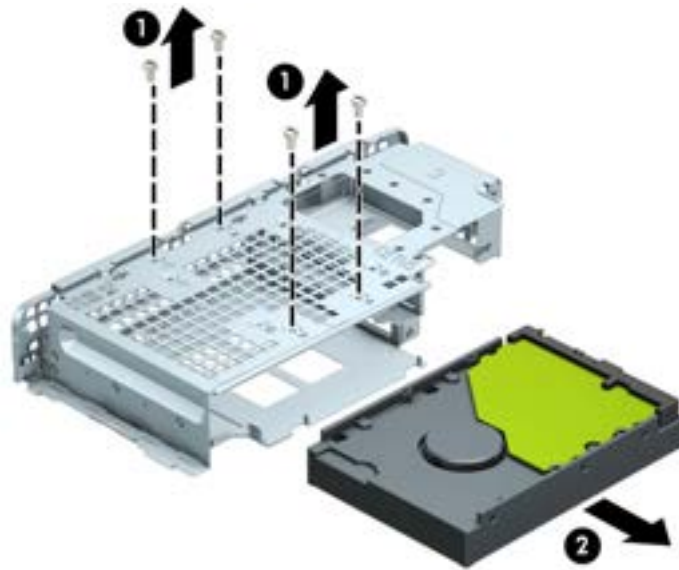

- If you are removing a 2.5-inch hard drive, remove the four screws that secure the drive to the drive cage (1) to release the drive (2).

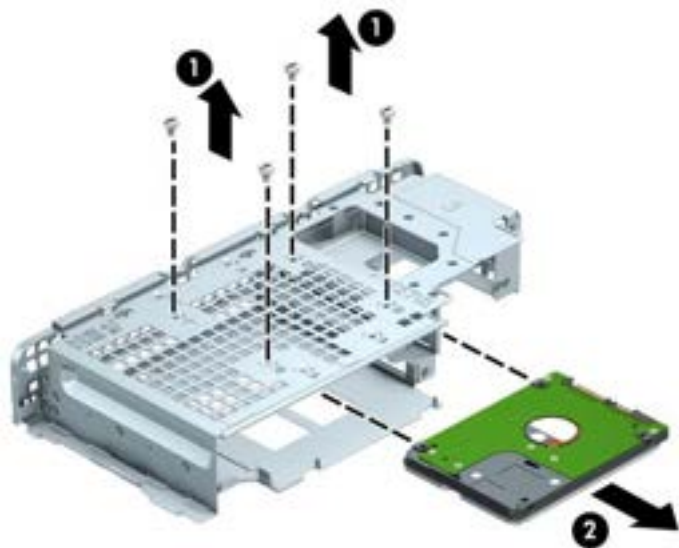

11. Install the new drive in the drive cage.

- If you are installing a 3.5-inch hard drive, slide the drive into the drive cage (1) and secure the drive with four 6-32 standard screws.

 **NOTE:** The four screw holes for the 3.5-inch hard drive are stamped “A” on the top of the drive cage.

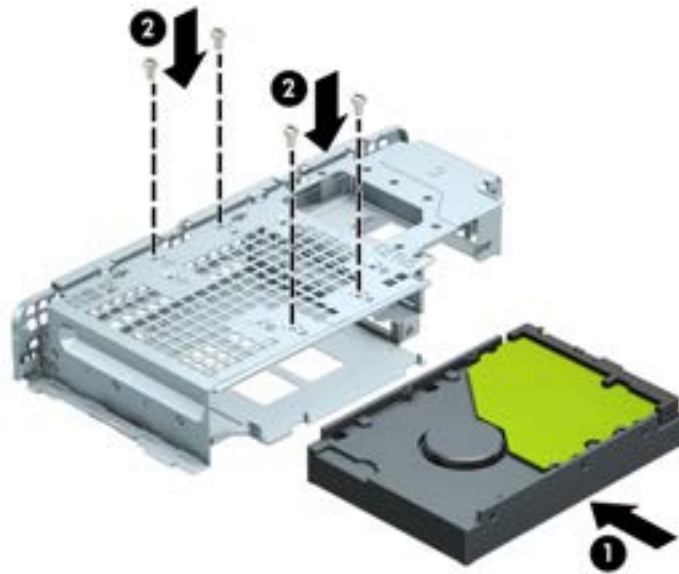

- If you are installing a 2.5-inch hard drive, slide the drive into the drive cage (1) and secure the drive with four M3 metric screws.

 **NOTE:** The four screw holes for the 2.5-inch hard drive are stamped “B” on the top of the drive cage.

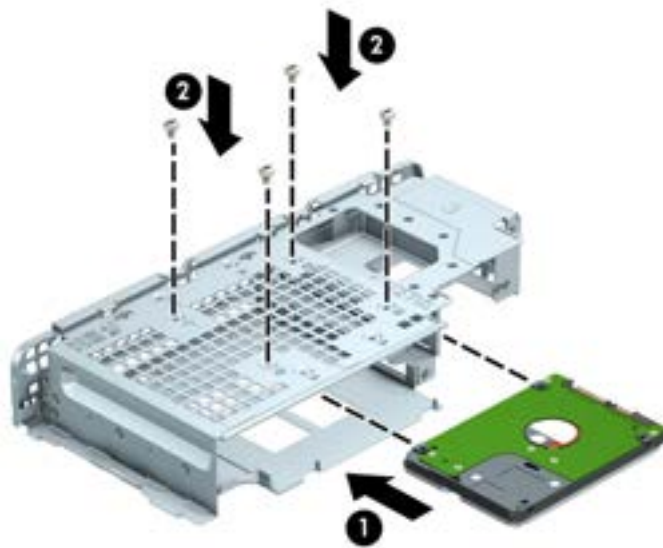

12. Hold the drive cage at an angle and insert the tabs on the side of the drive cage into the slots on the chassis (1), and then lower the other side of the drive cage down so that the latch snaps onto the chassis (2).

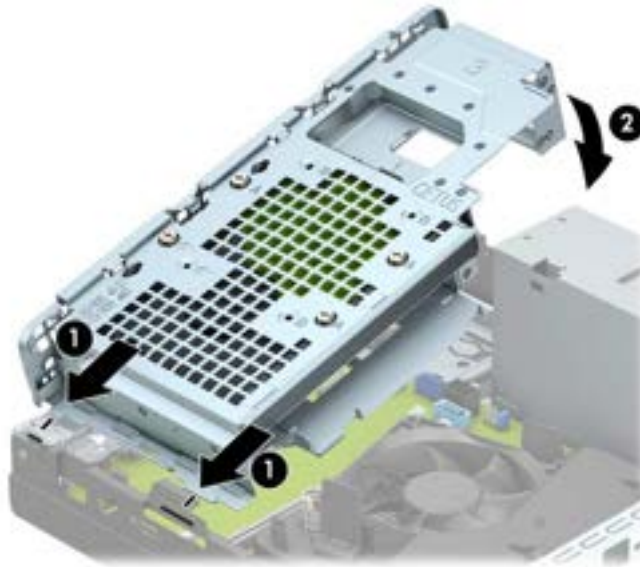

13. Connect the power cable (1) and data cable (2) to the rear of the hard drive.

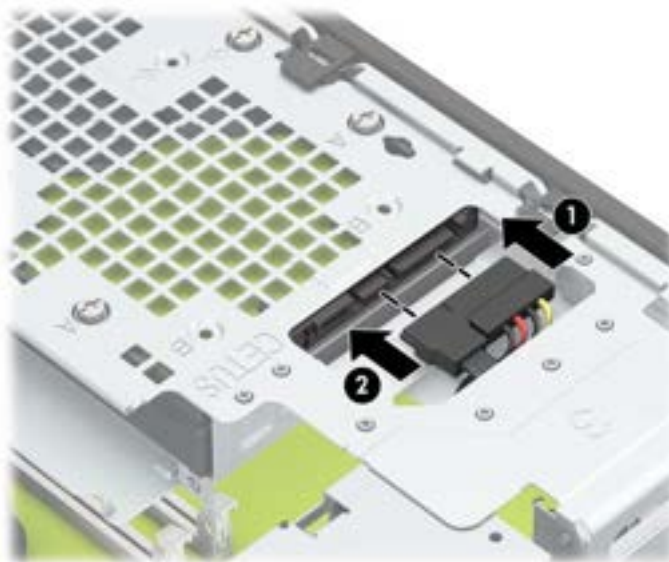

- Slide the optical drive through the front bezel all the way into the bay (1) so that it locks in place (2).

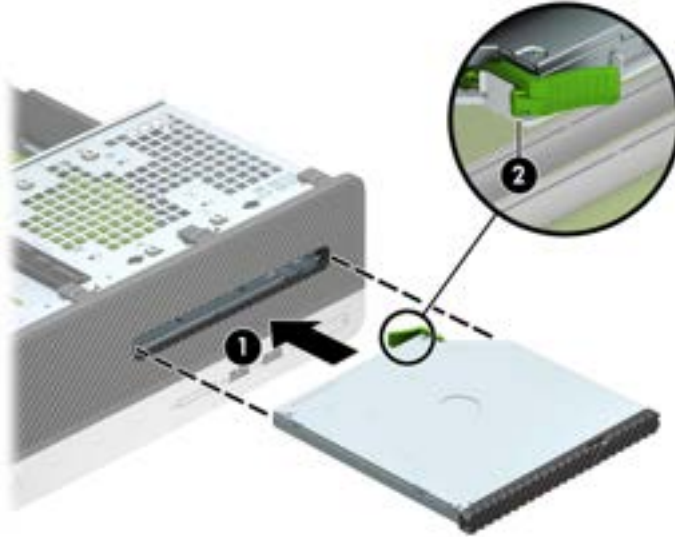

- Connect the power cable (1) and data cable (2) to the rear of the drive.



- Replace the access panel.
- Reconnect the power cord and any external devices, then turn on the computer.
- Lock any security devices that were disengaged when the access panel was removed.

Installing a security lock

The security locks displayed below and on the following pages can be used to secure the computer.

Security cable lock

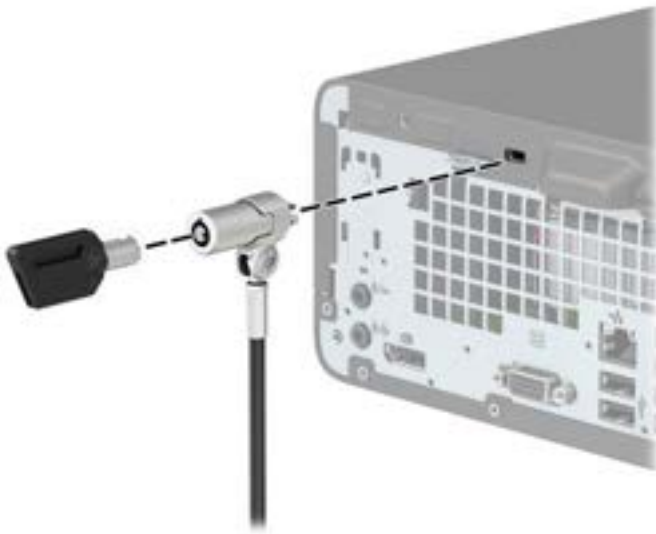

Padlock



HP Business PC Security Lock V2

1. Loop the security cable around a stationary object.



2. Attach the security cable fastener to a desktop using the appropriate screws for your environment (screws not provided) (1), and then snap the cover onto the base of the cable fastener (2).

 **NOTE:** This step is not necessary if you looped the security cable around a stationary object as shown in step 1.

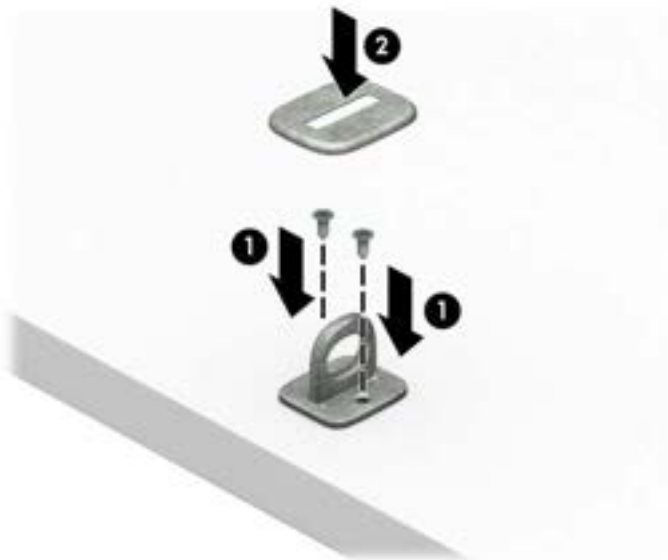

3. Slide the security cable through the security cable fastener.

 **NOTE:** This step is not necessary if you looped the security cable around a stationary object as shown in step 1.



4. If your workstation configuration includes a monitor that you want to secure, pull the two scissor hands of the monitor lock apart and insert the lock into the security slot on the rear of the monitor (1), close the scissor hands together to secure the lock in place (2), and then slide the cable guide through the center of the monitor lock (3).

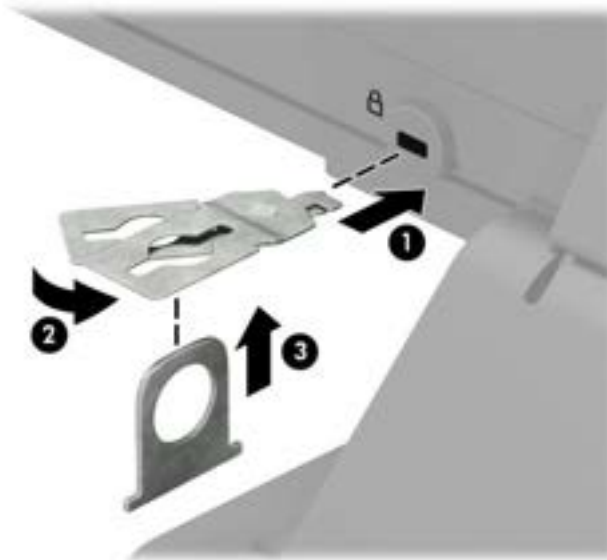

5. Slide the security cable through the security guide installed on the monitor.

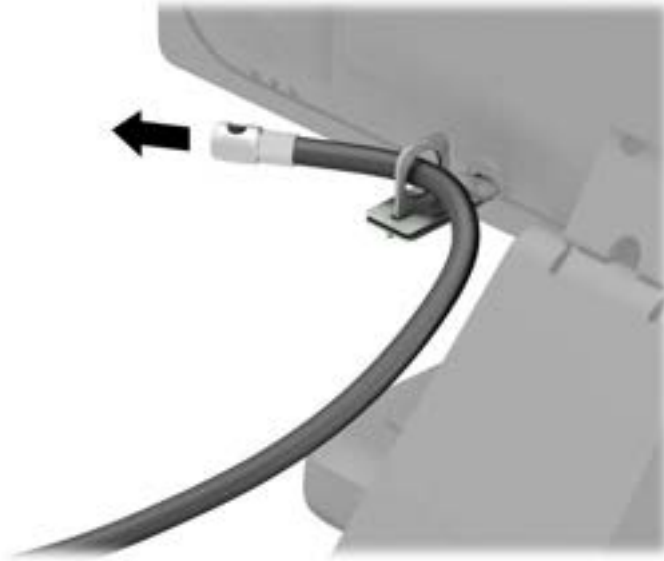

6. Attach the accessory cable fastener to a desktop using the appropriate screw for your environment (screw not provided) (1), and then place the accessory cables into the base of the fastener (2).



7. Slide the security cable through the holes in the accessory cable fastener.



8. Screw the lock to the chassis using the screw provided.

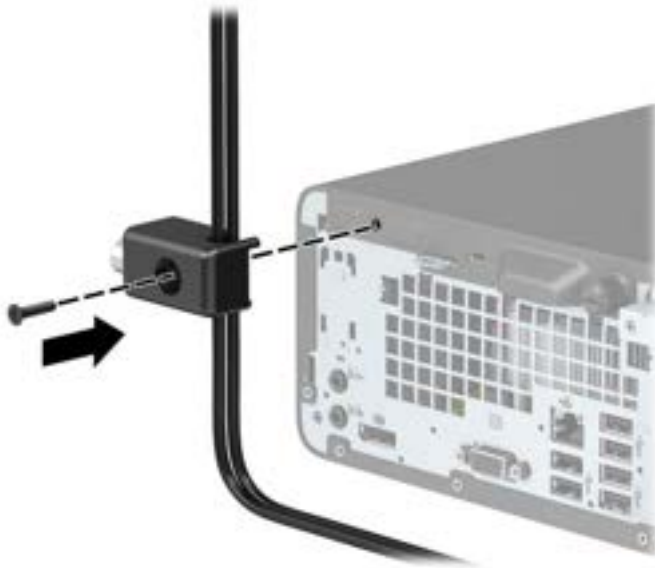

9. Insert the plug end of the security cable into the lock (1) and push the button in (2) to engage the lock. Use the key provided to disengage the lock.

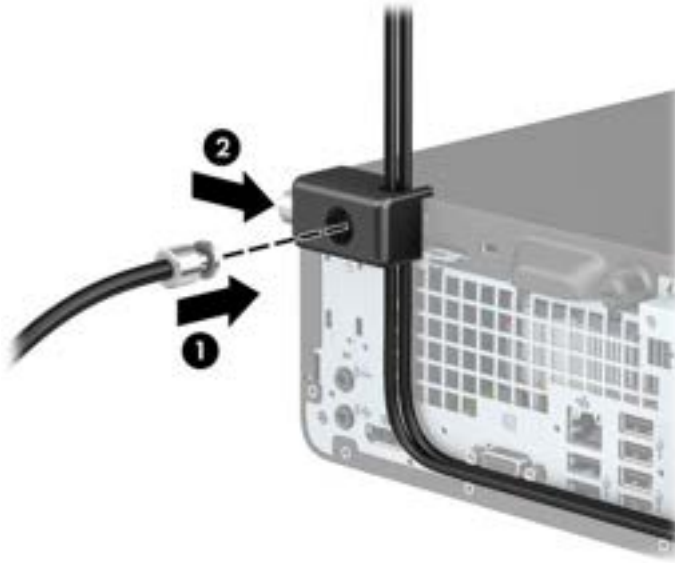

10. When you have completed all steps, all of the devices at your workstation will be secured.

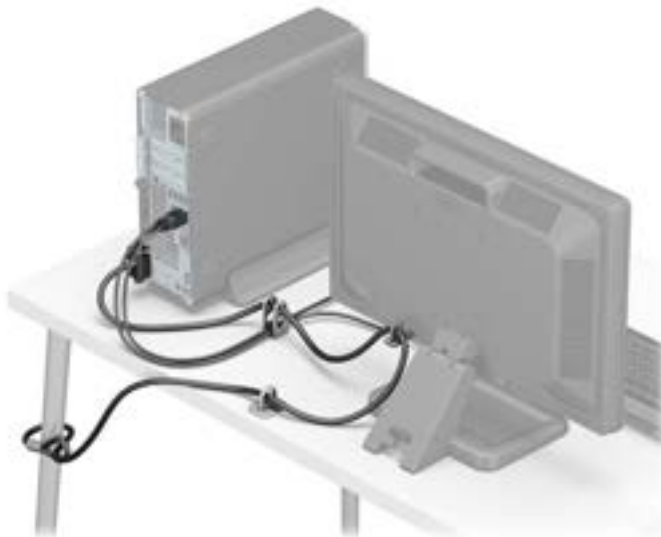

A Battery replacement

The battery that comes with the computer provides power to the real-time clock. When replacing the battery, use a battery equivalent to the battery originally installed in the computer. The computer comes with a 3-volt lithium coin cell battery.

 **WARNING!** The computer contains an internal lithium manganese dioxide battery. There is a risk of fire and burns if the battery is not handled properly. To reduce the risk of personal injury:

Do not attempt to recharge the battery.

Do not expose to temperatures higher than 60°C (140°F).

Do not disassemble, crush, puncture, short external contacts, or dispose of in fire or water.

Replace the battery only with the HP spare designated for this product.

 **CAUTION:** Before replacing the battery, it is important to back up the computer CMOS settings. When the battery is removed or replaced, the CMOS settings will be cleared.

Static electricity can damage the electronic components of the computer or optional equipment. Before beginning these procedures, ensure that you are discharged of static electricity by briefly touching a grounded metal object.

 **NOTE:** The lifetime of the lithium battery can be extended by plugging the computer into a live AC wall socket. The lithium battery is only used when the computer is NOT connected to AC power.

HP encourages customers to recycle used electronic hardware, HP original print cartridges, and rechargeable batteries. For more information about recycling programs, go to <http://www.hp.com/recycle>.

1. Remove/disengage any security devices that prohibit opening the computer.
2. Remove all removable media, such as compact discs or USB flash drives, from the computer.
3. Turn off the computer properly through the operating system, then turn off any external devices.
4. Disconnect the power cord from the power outlet and disconnect any external devices.

 **CAUTION:** Regardless of the power-on state, voltage is always present on the system board as long as the system is plugged into an active AC outlet. You must disconnect the power cord to avoid damage to the internal components of the computer.

5. Remove the computer access panel. See [Removing the computer access panel on page 5](#).
6. Remove the drive cage.
7. Locate the battery and battery holder on the system board.

 **NOTE:** On some computer models, it may be necessary to remove an internal component to gain access to the battery.

8. Depending on the type of battery holder on the system board, complete the following instructions to replace the battery.

Type 1

- a. Lift the battery out of its holder.

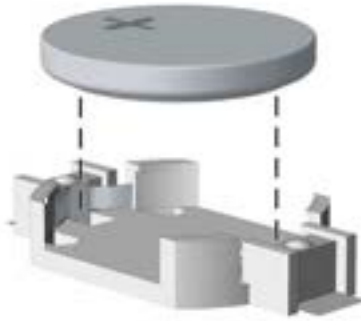

- b. Slide the replacement battery into position, positive side up. The battery holder automatically secures the battery in the proper position.

Type 2

- a. To release the battery from its holder, squeeze the metal clamp that extends above one edge of the battery. When the battery pops up, lift it out (1).
- b. To insert the new battery, slide one edge of the replacement battery under the holder's lip with the positive side up. Push the other edge down until the clamp snaps over the other edge of the battery (2).

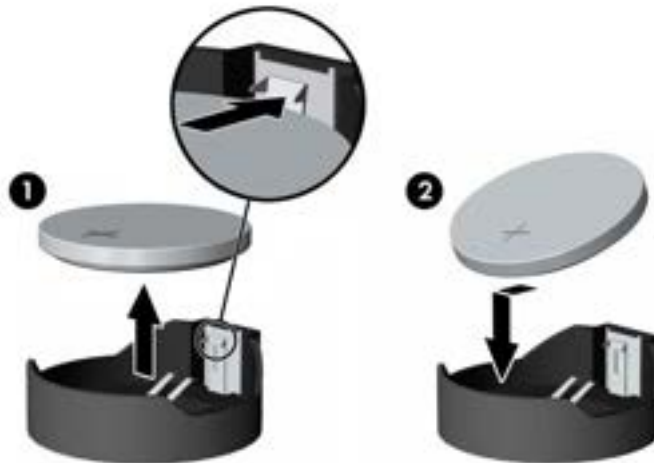

Type 3

- a. Pull back on the clip (1) that is holding the battery in place, and remove the battery (2).

- b. Insert the new battery and position the clip back into place.

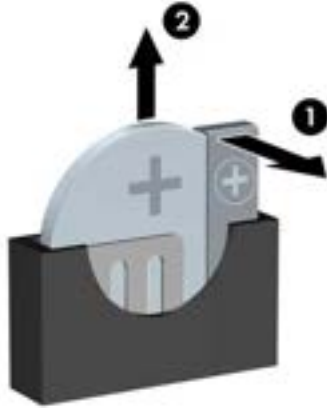

 **NOTE:** After the battery has been replaced, use the following steps to complete this procedure.

9. Replace the computer access panel.
10. Reconnect the power cord and any external devices, then turn on the computer.
11. Reset the date and time, your passwords, and any special system setups using Computer Setup.
12. Lock any security devices that were disengaged when the computer access panel was removed.

B Electrostatic discharge

A discharge of static electricity from a finger or other conductor may damage system boards or other static-sensitive devices. This type of damage may reduce the life expectancy of the device.

Preventing electrostatic damage

To prevent electrostatic damage, observe the following precautions:

- Avoid hand contact by transporting and storing products in static-safe containers.
- Keep electrostatic-sensitive parts in their containers until they arrive at static-free workstations.
- Place parts on a grounded surface before removing them from their containers.
- Avoid touching pins, leads, or circuitry.
- Always be properly grounded when touching a static-sensitive component or assembly.

Grounding methods

There are several methods for grounding. Use one or more of the following methods when handling or installing electrostatic-sensitive parts:

- Use a wrist strap connected by a ground cord to a grounded workstation or computer chassis. Wrist straps are flexible straps with a minimum of 1 megohm +/- 10 percent resistance in the ground cords. To provide proper ground, wear the strap snug against the skin.
- Use heelstraps, toestraps, or bootstraps at standing workstations. Wear the straps on both feet when standing on conductive floors or dissipating floor mats.
- Use conductive field service tools.
- Use a portable field service kit with a folding static-dissipating work mat.

If you do not have any of the suggested equipment for proper grounding, contact an HP authorized dealer, reseller, or service provider.



NOTE: For more information on static electricity, contact an HP authorized dealer, reseller, or service provider.

C Computer operating guidelines, routine care and shipping preparation

Computer operating guidelines and routine care

Follow these guidelines to properly set up and care for the computer and monitor:

- Keep the computer away from excessive moisture, direct sunlight, and extremes of heat and cold.
- Operate the computer on a sturdy, level surface. Leave a 10.2-cm (4-inch) clearance on all vented sides of the computer and above the monitor to permit the required airflow.
- Never restrict the airflow into the computer by blocking any vents or air intakes. Do not place the keyboard, with the keyboard feet down, directly against the front of the desktop unit as this also restricts airflow.
- Never operate the computer with the access panel or any of the expansion card slot covers removed.
- Do not stack computers on top of each other or place computers so near each other that they are subject to each other's re-circulated or preheated air.
- If the computer is to be operated within a separate enclosure, intake and exhaust ventilation must be provided on the enclosure, and the same operating guidelines listed above will still apply.
- Keep liquids away from the computer and keyboard.
- Never cover the ventilation slots on the monitor with any type of material.
- Install or enable power management functions of the operating system or other software, including sleep states.
- Turn off the computer before you do either of the following:
 - Wipe the exterior of the computer with a soft, damp cloth as needed. Using cleaning products may discolor or damage the finish.
 - Occasionally clean the air vents on all vented sides of the computer. Lint, dust, and other foreign matter can block the vents and limit the airflow.

Optical drive precautions

Be sure to observe the following guidelines while operating or cleaning the optical drive.

Operation

- Do not move the drive during operation. This may cause it to malfunction during reading.
- Avoid exposing the drive to sudden changes in temperature, as condensation may form inside the unit. If the temperature suddenly changes while the drive is on, wait at least one hour before you turn off the power. If you operate the unit immediately, it may malfunction while reading.
- Avoid placing the drive in a location that is subject to high humidity, extreme temperatures, mechanical vibration, or direct sunlight.

Cleaning

- Clean the panel and controls with a soft, dry cloth or a soft cloth lightly moistened with a mild detergent solution. Never spray cleaning fluids directly on the unit.
- Avoid using any type of solvent, such as alcohol or benzene, which may damage the finish.

Safety

If any object or liquid falls into the drive, immediately unplug the computer and have it checked by an authorized HP service provider.

Shipping preparation

Follow these suggestions when preparing to ship the computer:

1. Back up the hard drive files to an external storage device. Be sure that the backup media is not exposed to electrical or magnetic impulses while stored or in transit.



NOTE: The hard drive locks automatically when the system power is turned off.

2. Remove and store all removable media.
3. Turn off the computer and external devices.
4. Disconnect the power cord from the electrical outlet, then from the computer.
5. Disconnect the system components and external devices from their power sources, then from the computer.



NOTE: Ensure that all boards are seated properly and secured in the board slots before shipping the computer.

6. Pack the system components and external devices in their original packing boxes or similar packaging with sufficient packing material to protect them.

D Accessibility

HP designs, produces, and markets products and services that can be used by everyone, including people with disabilities, either on a stand-alone basis or with appropriate assistive devices.

Supported assistive technologies

HP products support a wide variety of operating system assistive technologies and can be configured to work with additional assistive technologies. Use the Search feature on your device to locate more information about assistive features.

 **NOTE:** For additional information about a particular assistive technology product, contact customer support for that product.

Contacting support

We are constantly refining the accessibility of our products and services and welcome feedback from users. If you have an issue with a product or would like to tell us about accessibility features that have helped you, please contact us at (888) 259-5707, Monday through Friday, 6 a.m. to 9 p.m. Mountain Time. If you are deaf or hard-of-hearing and use TRS/VRS/WebCapTel, contact us if you require technical support or have accessibility questions by calling (877) 656-7058, Monday through Friday, 6 a.m. to 9 p.m. North American Mountain Time.

 **NOTE:** Support is in English only.

Index

A

- access panel
 - removal 5
 - replacement 6
- accessibility 44

B

- battery replacement 38

C

- computer operating guidelines 42

D

- DIMMs. *See* memory
- drives
 - cable connections 22
 - installation 22
 - locations 21

E

- electrostatic discharge, preventing damage 41
- expansion card
 - installation 18
 - removal 18

F

- front bezel
 - blank removal 8
 - removal 7
 - replacement 8
- front panel components 2

H

- hard drive
 - installation 26
 - removal 26

I

- installation guidelines 4
- installing
 - battery 38
 - computer access panel 6
 - drive cables 22
 - expansion card 18

- hard drive 26
- memory 11
- optical drive 24

L

- locks
 - cable lock 32
 - HP Business PC Security Lock 33
 - padlock 32

M

- memory
 - installation 11
 - socket population 11
 - specifications 11

O

- optical drive
 - cleaning 43
 - installation 24
 - precautions 43
 - removal 23

P

- product ID location 3

R

- rear panel components 3
- removing
 - battery 38
 - computer access panel 5
 - expansion card 18
 - front bezel 7
 - hard drive 26
 - optical drive 23
 - optical drive bezel blank 8

S

- security
 - cable lock 32
 - HP Business PC Security Lock 33
 - padlock 32
- serial number location 3
- shipping preparation 43
- system board connectors 10

T

- tower conversion 9

V

- ventilation guidelines 42